



# Tenants' Handbook



[www.cbh.org](http://www.cbh.org)

# ABOUT YOUR HANDBOOK

Your Tenant Handbook is split into 3 parts:

## YOU AND CBH

About you and our relationship

## YOU AND YOUR HOME

Rights and responsibilities

## YOU AND YOUR NEIGHBOURHOOD

Where you live and your community

## GENERAL DEFINITIONS

Your legal rights and responsibilities as a tenant are set out in your tenancy conditions. We may change these conditions after consulting our tenants. The official address for you to serve notices on the Council (including notices in proceedings) is:

Cheltenham Borough Homes Ltd  
Cheltenham House, Clarence Street, Cheltenham GL50 3JR

# CONTENTS

## YOU AND CBH

		page
<b>Section 1</b>	<b>CBH</b>	<b>7</b>
	About CBH	8
	Our Vision	8
	Our Objectives	8
<b>Section 2</b>	<b>Customer Services</b>	<b>9</b>
	Contact Us	10
	Compliments, Comments and Complaints	12
	Equality and Diversity	15
<b>Section 3</b>	<b>Community Services</b>	<b>17</b>
	Ways to get involved	18
	Employment Initiatives	22
	Regeneration and New Homes	24
<b>Section 4</b>	<b>Governance</b>	<b>25</b>
	The Board of Directors	26
	Tenant Scrutiny Improvement Panel (TSIP)	27
<b>Section 5</b>	<b>Your Tenancy</b>	<b>29</b>
	About your tenancy	30
	Tenancy Support	35
	Bonus Schemes	36
	Safeguarding Vulnerable Children and Adults	37

## YOU AND YOUR HOME

<b>Section 1</b>	<b>Rent</b>	<b>41</b>
	Paying your rent	42
	Rent you owe	43
	Money Advice	44
<b>Section 2</b>	<b>Home Contents Insurance</b>	<b>47</b>
<b>Section 3</b>	<b>Moving to a new home</b>	<b>49</b>
	Transfers	50
	Mutual Exchanges	52

*continued overleaf*

# CONTENTS



		<i>page</i>
<b>Section 4</b>	<b>Buying your home</b>	<b>53</b>
	Right to Buy	54
	Right to Acquire	54
	New Build Homebuy	55
	Resales	56
	Low Cost Home Ownership	56
<b>Section 5</b>	<b>Sheltered Accommodation</b>	<b>57</b>
<b>Section 6</b>	<b>Property Maintenance</b>	<b>61</b>
	Home Improvement	62
	Looking after your home	64
	Looking after communal areas	66
<b>Section 7</b>	<b>Repairs</b>	<b>69</b>
	Report a Repair	70
	Emergencies	78
<b>Section 8</b>	<b>Repairs Guide</b>	<b>83</b>
	Investing in Homes and Neighbourhoods	155

## YOU AND YOUR NEIGHBOURHOOD

<b>Section 1</b>	<b>Your Neighbourhood Handbook</b>	<b>159</b>
<b>Section 2</b>	<b>Being a good neighbour</b>	<b>161</b>
	Anti-social Behaviour	162
	Domestic Violence and Abuse	164
	Harassment and Hate Crime	166
	Victim Support	167
<b>Section 3</b>	<b>Neighbourhood Works</b>	<b>169</b>
	Annual Programme of Work	
	<b>CBH Useful Contacts</b>	<b>172</b>

Dear Tenant,

Welcome to your new handbook. The Tenants' Handbook is a guide to our services and outlines the rights and responsibilities of both CBH and yourself.

If you have any feedback regarding this handbook, please contact our Customer Services Team on 0800 408 0000, who will be happy to discuss any comments with you.

We hope you will be happy in your home.

**Cheltenham Borough Homes**

\*The handbook is for information only and any legal positions remain unaltered.



# YOU ABOUT CBH

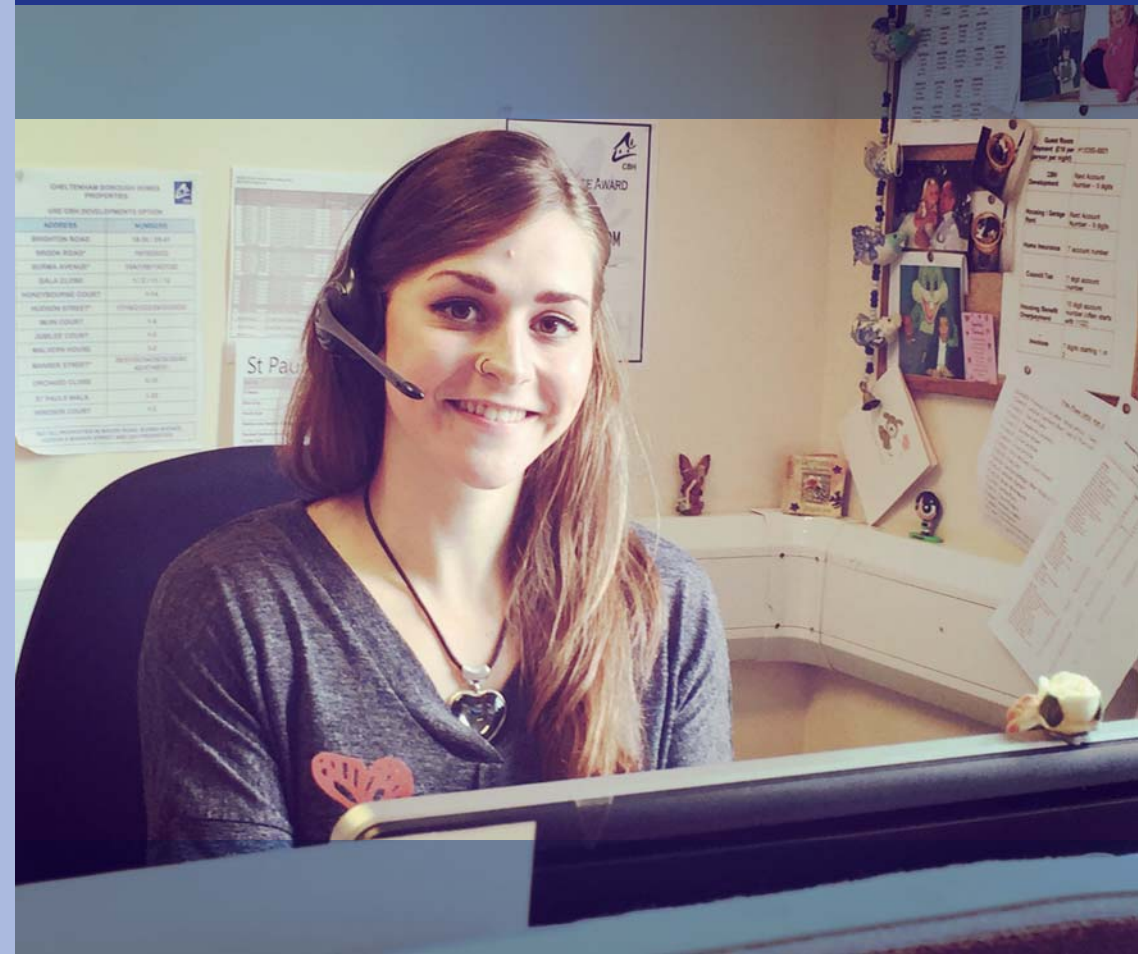

# YOU AND CBH

## Section 1

### CBH

---

About CBH  
Our Vision  
Our Objectives

## Section 2

### Customer Services

---

Contact Us  
Compliments, Comments and Complaints  
Equality and Diversity

## Section 3

### Community Services

---

Ways to get involved  
Employment Initiatives  
Regeneration and New Homes

## Section 4

### Governance

---

The Board of Directors  
Tenant Scrutiny Improvement Panel (TSIP)

## Section 5

### Your Tenancy

---

About your tenancy  
Tenancy Support  
Bonus Schemes  
Safeguarding Vulnerable Children and Adults

## Section 1

# ABOUT CBH

## ABOUT

---

About CBH

---

Our Vision

---

Our Objectives

---

# ABOUT CBH

Cheltenham Borough Homes Ltd. was established as an independent company in April 2003 to deliver the Council's housing services to you.

This means that the Council still owns your home and we manage the homes day to day. We are managed by a Board of 10 people, including tenants and leaseholders, and we have a real commitment to involving tenants in all aspects of our service. If you would like to attend a Board meeting, or you are interested in becoming a tenant Board member please contact the Company Secretary on 0800 408 0000 and select Customer Services.

## Our Vision

Is that our customers are able to improve their quality of life and live in good quality homes, in places where they choose to live.

## Our Objectives

- Make a difference to peoples' lives.
- Provide high quality homes.
- Modernise service delivery.
- Be a viable and responsible business.

## Section 2

# CUSTOMER SERVICES

### CUSTOMER SERVICES

Contact Us

Compliments,  
Comments and  
Complaints

Equality and  
Diversity

# CONTACT CBH

## FREEPHONE

0800 408 0000

0300 555 0121 (local call rate)

## DO IT ONLINE

Pay your rent, report a repair,  
login to your MyCBH Account at:

[www.cbh.org](http://www.cbh.org)

Our two area offices deal with all matters relating to your tenancy including:

- anti-social behaviour
- cash collection
- current and former rent arrears
- money and benefit advice
- exchanges
- neighbourhood management issues
- repairs and improvements
- tenancy management issues

You can:

- enquire about any issue that relates to your tenancy
- find out how you can be involved with CBH
- pay your rent
- pay your home contents insurance payments
- pay any debts owed to the Council

You can access our services in person from two locations:

### CBH Office

#### Oakley Community Resource Centre

Cheltenham Borough Homes  
Oakley Community Resource Centre  
113A Clyde Crescent  
Cheltenham GL52 5QL

### Our opening hours

Monday 9am to 5pm  
Tuesday 9am to 5pm  
Wednesday 10am to 5pm  
Thursday 9am to 5pm  
Friday 9am to 5pm



### CBH Office

#### Hester's Way Area Office

Cheltenham Borough Homes  
Hester's Way Community Resource Centre  
Cassin Drive,  
Cheltenham GL51 7SU

### Our opening hours

Monday 9am to 5pm  
Tuesday 9am to 5pm  
Wednesday 10am to 5pm  
Thursday 9am to 5pm  
Friday 9am to 5pm





# COMPLIMENTS, COMMENTS AND COMPLAINTS

## Listening to your views:

CBH is committed to providing quality services which meet your needs. In order to do this we need to know what you think of the services we provide so that we can continually review and improve them. We value every compliment, comment or complaint we receive. Your views will help us plan our services.

## Every customer who makes a complaint has the right to:

- be treated courteously, have the complaint taken seriously and dealt with promptly, efficiently and fairly in accordance with our policy
- be told how quickly, and by whom, it will be dealt with and when to expect a reply
- to be kept informed at all stages of the progress of your complaint
- to be told what you can do if you are not satisfied with the reply you receive at any stage

- to receive an explanation of the reasons for our decisions
- to receive an immediate apology if one is due
- to have any defects or errors identified and put right promptly.

## Making a complaint

CBH is passionate about being given the opportunity to put something right when you believe it has gone wrong.

If you are unhappy and wish to make a complaint, you can use the following methods:

- By Freephone: 0800 408 0000 / 0300 555 0121 (local call rate)
- In person to a member of CBH staff
- By email: CBHcustomerrelations@cbh.org

- In writing to:  
Customer Services Team Leader  
Cheltenham Borough Homes  
Hester's Way Community Resource Centre  
Cassin Drive  
Cheltenham GL51 7SU

Your complaint will be acknowledged within three working days and you will receive a unique complaint reference number. We aim to resolve all complaints within 10 working days. However, on occasions complex cases may take a little longer. If your complaint cannot be resolved within 10 working days you will be contacted and consulted on an appropriate timescale that we will agree with you.

## Our Three Stage Procedure

CBH has a three stage complaints procedure.

### Stage one

After making a complaint your feedback will be passed to a staff member to investigate. The investigation looks into the complaint and identifies any learning points for the future. If after the investigation you remain dissatisfied with our response, you can request a stage two review by contacting the Customer Services Team Leader on 0800 408 0000 / 0300 5550121.

### Stage two

The Customer Services Team Leader will discuss with you the reasons why you are dissatisfied and arrange for your complaint to be escalated.

You will then receive a stage two acknowledgement letter. A senior CBH staff member will be appointed to review the case and respond within ten working days. In some cases the time limit may be extended, but you will be consulted to determine an appropriate deadline.



## Stage three

If you are still dissatisfied with our response, you can contact the Customer Services Team Leader who will discuss with you the reasons why you are dissatisfied and requesting your complaint be taken to a stage 3 review panel meeting. The review panel is made up of members of the Board of CBH and either the Chief Executive or their nominee. The panel will meet within 6 weeks of the stage three escalation date and you will be invited to come to the panel to put forward your case.

The stage three review panel will provide CBH's final response within 10 working days of the panel meeting and once given we will not review the case further without good reason.

## Local Government Ombudsman

If you are still not happy with the way your complaint has been dealt with you can refer the matter to the Housing Ombudsman Service.

Please note that in most cases the Ombudsman will only consider a complaint once it has been through the CBH complaints process.

The Housing Ombudsman Service can be contacted:

81 Aldwych  
London  
WC2B 4HN

Tel: 0300 111 3000  
Fax: 020 7831 1942  
info@housing-ombudsman.org.uk  
www.housing-ombudsman.org.uk

# EQUALITY AND DIVERSITY

*"Promoting Equality and Valuing Difference"*

### **Equality means:**

Ensuring that people are treated fairly and have the same opportunities as others regarding employment and services.

### **Diversity means:**

Appreciating that everybody is unique and that we should embrace individual differences to benefit our communities and society in general.

CBH are committed to promoting equality and fairness in the way we treat customers, staff, partners and other stakeholders.

The Equality Act 2010 provides protection for nine characteristics;

- Race
- Sex
- Disability
- Sexual Orientation
- Religion or Belief
- Age
- Gender Reassignment
- Marriage and Civil Partnership
- Pregnancy and Maternity

We work hard to tackle and eliminate discrimination through good practice, provision of training, robust policies, and working in partnership with voluntary and statutory partners.

We will go beyond the legal minimum required to promote equal opportunities and to address disadvantage.

CBH is an integral part of the local community, and we recognise and value the diversity of the population we serve. We are committed to building an environment in which people feel valued, respected and encouraged to take part in community activities.

Our offices and community venues are accessible via level access on the ground floor or via a lift if access is required to other floors.

We want to ensure that the services we provide are accessible, do not discriminate against anyone and are open to influence by our customers.

To ensure that our services are fully accessible to all, we aim to meet diverse needs through provision of support, including:

- Communication in alternative formats e.g. Braille, large print, audio, Type Talk, online/ email, tenant self-service portal, social media, or text
- Browse aloud on our website (reads the text out loud to you, changes text size, translates, and more)
- Provision of a hearing loop or personal listening device
- Language interpreter or translation
- British Sign Language interpreter
- Providing transport (subject to needs assessment)
- Support for carers (subject to needs assessment)
- Training

We will consider all requests for support to meet diverse need and encourage you to contact us if you would like more information or support.

## Section 3

# COMMUNITY SERVICES

### COMMUNITY SERVICES

Ways to get involved

Employment Initiatives

Regeneration and New Homes

# COMMUNITY INVOLVEMENT

The Community Involvement Team provides a wide range of opportunities for customers to become involved to influence, monitor and improve CBH service delivery. We do this by making sure you have as many opportunities as possible to let us know your views on CBH, the services we provide and the neighbourhoods we manage.

Our menu of involvement opportunities offers a level of involvement that suits all. You may wish to get involved from the comfort of your own home or come along to a meeting, involve yourself in a community event or even become a member of a CBH working group or Residents' Association.

With the benefit of your involvement we aim to increase your level of satisfaction with your home, neighbourhood and the services we provide for you. We will do this by listening carefully to what you tell us and feeding back to you the actions we have taken as a result of your valuable input.

We will provide feedback to all our customers on our involvement activities through our annual Customer Involvement Impact Report.

***We have a variety of options for involvement with CBH and aim to attract a diverse range of people.***

## WAYS TO GET INVOLVED

### Customer Profiling Form (at home)

The CBH Profiling form helps us identify customers who want to play a greater role in working with CBH and the community. Personal data is also collected to update our records. We are then able to tailor our services, for example how we communicate with you and how we respond accordingly.

### Repairs Satisfaction Survey (at home)

Satisfaction reply slips are sent out to your home with confirmation of completion for your repair request. We monitor all your comments and use your feedback information to improve our services and our customer promise. Satisfaction is monitored by the Technical Services Working Group.

### Anti Social Behaviour Questionnaire (at home)

These are questionnaires sent out to all customers following the closure of any ASB case. Your feedback helps us to monitor your satisfaction in the way we deal with anti social behaviour.

### Phone Survey (at home)

We carry out a random selection of phone based surveys for a range of CBH service areas which include Responsive Repairs, Housing Revenues, Anti Social Behaviour and New Tenancies. This is to ensure we continue to receive your views to help us improve our services.

### Customer Auditors, Mystery Shopping (at home)

Mystery shopping is a form of market research where individuals are trained to observe, experience and evaluate the full range of CBH services. Effective mystery shopping leads to benefits all round – for you, our customer, CBH and staff. Mystery shoppers act out a typical 'customer experience' via phone calls, visits, observations, letters and emails.

### CBH Communication (at home)

We publish four editions of the CBH News every year for all our customers. Information is also available on our website.

### Board Membership (at a meeting)

Tenants are encouraged to put themselves forward for Board membership so that they can represent the interests of all CBC and CBH tenants in the borough. This rewarding role is voluntary and unpaid, though expenses are met.

### Tenant Scrutiny Improvement Group (at a meeting)

TSIP has been established to scrutinise and recommend improvements to services offered by CBH and is formally recognised within the governance structure of the organisation. The structure ensures that customers are measuring, testing and monitoring the services they receive and customers are influencing the development of the business.

### Shaping Services Working Group (at a meeting)

Regular meetings with CBH staff to discuss, develop and monitor a particular service, for example repairs. Working Group members also shadow staff, attend training, hold open days and carry out inspections.

### Focus Groups (at a meeting)

Groups of 10 – 12 people who meet once or twice to give their views on a particular subject. Recent focus groups have been used to capture views on our approach to anti-social behaviour, grounds maintenance and local offers.

### Leaseholder involvement (at a meeting)

A CBH Leaseholders' meeting is held every two months to look at leaseholder issues.

### Tenant and Resident Associations (TARA's) (in your neighbourhood)

TARA's are fully constituted groups of residents who represent a particular geographic area (e.g. Oakley) or special interest group (e.g. the Leaseholders Forum). These Associations are made up of an elected committee, each with a Chair, Secretary and Treasurer. We provide accredited Associations with practical and financial support, including public liability insurance.

### Estate Inspections (in your neighbourhood)

Customers are invited to attend regular inspections of neighbourhood areas with local housing officers and customer representatives. Attendees receive a written report of actions and outcomes.

### Community Sponsorship

CBH have a Community Sponsorship Scheme which enables tenants to apply for up to £500 to support activities that will strengthen their community. Examples to date include a bingo machine, football schemes and gardening competition. Applications are invited all year round.

# EMPLOYMENT INITIATIVES

CBH has developed a range of opportunities for customers aimed at offering choice, raising confidence, developing transferable skills and assisting in the removal of barriers into education, training, volunteering and employment. If you are unemployed, or if you want to improve your skills, then we can help you take the steps you need to reach your goals. You can talk to us about your situation and the kind of employment you're looking for and we'll help you to find a job that works for you. The Employment Initiatives Project, the first of its kind for CBH, offers free access to:

## School Work Experience Programme (15-16 year olds)

This involves working in partnership with local schools and colleges to provide placements for our younger customers. These placements are usually for a one week period. In exceptional circumstances we have previously worked closely with young people, their families and schools to offer

extended 12 month placements for those young people who are experiencing difficulties in school.

## Apprenticeships (16-24 year olds)

This involves working in partnership with our contractors to provide apprenticeship opportunities to young people aged 16 – 24. We have also been successful in supporting younger people to gain apprenticeships with local businesses and training providers. Apprenticeships are work-based training programmes designed around the needs of employers, leading onto a nationally recognised qualification. Most of the training is 'on the job' and usually involves a 'day-release' with a local training provider.

## 13 Week Work Placements (16 year olds and above)

CBH are keen to work with Jobcentre Plus contractors to offer work experience under the New Deal Programme for the long term unemployed. These placements are designed to offer valuable and meaningful 'hands-on' experience for people. This presents an ideal opportunity to develop a work routine, increase your confidence, and gain new skills as well as updating your C.V. and gaining a current work reference.

## Individual Bespoke Support (16 year olds and above)

This is a tailor-made programme designed specifically to suit you. It aims to offer support by assessing individual skills and needs areas. This is then used to create an agreed individual employment plan. This plan guides the work undertaken during regular one-to-one meetings. These meetings are used to discuss progress, available options and if agreed, signposting to specialist services when required.

Traditional employment support is also offered during these one-to-one sessions, such as:

- C.V. writing
- Application Forms
- Covering Letters
- Disclosure of convictions
- Job Searching Techniques
- Mock Interviews
- Signposting to training, volunteering providers and specialist services
- Aftercare (individual support)

This aims to support all individuals who have completed their initial programme who would also benefit from continued one-to-one support. After you have found work, we'll stay in touch with you and offer you support for as long as you need us to.

# REGENERATION AND NEW HOMES

At CBH we are committed to delivering high quality new build homes to meet local housing need. We also have a strong working partnership with Cheltenham Borough Council (CBC) to redevelop and transform disused areas of Cheltenham with affordable lifetime homes. Our most recent completed developments include:

**St Pauls Phase 2** – The second phase of our large scale regeneration of St Paul's was completed in May 2015. Located on what was Crabtree Place, 24 new homes were made available for affordable rent and transformational improvements were carried out to a number of existing homes.

**Further garage site redevelopments** – Completion of the 10 new CBC owned properties, a mix of four 1 and 2 bed flats and five 3 bed houses and one 4 bed house at Redgrove Road, Haweswater Road, Coniston Rad and Parkbury Close was completed in August 2016.

**Swindon Road** – In February 2017 works to provide 10 new council owned homes on the former commercial site at Swindon Road completed. The scheme has delivered five 1 bed flats, three 2 bed flats and two 2 bed houses. The properties were offered first to armed forces veterans and their families and are built to be adaptable, lifetime homes which have been designed to encourage a feeling of community.

## Contacts

Community Services  
Hesters Way Resource Centre  
Cassin Drive  
Cheltenham GL51 7SU

Tel: 0800 408 00 00

[www.cbh.org](http://www.cbh.org)

## Section 4

# GOVERNANCE

## GOVERNANCE

The Board of  
Directors

Tenant Scrutiny  
Improvement Panel  
(TSIP)

# HOW WE ARE GOVERNED

## The Board of Directors

The overall role of the Board is to provide strategic direction and control of CBH, to agree its Vision and Values, and to ensure that these are delivered. Board members are ambassadors for the Company and are expected to act in the best interests of the key stakeholders of CBH at all times.

The CBH Board of Directors is currently (as at 2017) made up from 10 non-executive (voluntary) members: three places are reserved for tenants and two for members nominated by Cheltenham Borough Council. The remaining five places can be filled by either tenants or independent members of the public who bring the right skills to the Board.

The Council is the sole member of the company and is represented on the Board by a Council Member stakeholder representative.

The Board meets regularly to approve the overall plans and budgets of the company. The Board also receives regular reports on performance against these plans and budgets from staff.

The Board has an Audit & Risk Committee which has responsibility for specific tasks delegated from the Board.

For more information please contact the Company Secretary on 0800 408 0000.

# TENANT SCRUTINY IMPROVEMENT PANEL (TSIP)

The views, aspirations and priorities of tenants, are at the heart of what we do.

The Tenant Scrutiny Panel (TSIP) embraces this commitment and enables real scrutiny and accountability of the organisation and its services and ultimately paves the way for tenant led self-regulation.

TSIP is formally recognised within our governance structures. This means that tenants are measuring, testing and monitoring the services they receive and influencing the development of the business.

TSIP is made up of tenants who scrutinise our services across the six CBH constituencies that make up the borough of Cheltenham. This ensures that both service concerns and neighbourhood issues are highlighted and addressed.

The membership of the group includes;

Four places for an elected Chair from each of the CBH Working Groups;

Five places will be held for Community Representatives from across CBH constituency areas.

Each member works with the Board, senior Leadership Teams, Officers and stakeholders as well as being accountable to the wider tenant body.

For more information please contact the Community Involvement Team on 0800 408 0000.



## Section 5

# YOUR TENANCY

### YOUR TENANCY

---

About your Tenancy

---

Tenancy Support

---

Bonus Schemes

---

Safeguarding  
Vulnerable Children  
and Adults

---

# YOUR TENANCY

## A Secure Tenancy

Most tenants of Cheltenham Borough Council have a secure tenancy. This means that as long as you keep to the conditions of your tenancy, you have a legal right to stay in your home. You will find these conditions in your tenancy agreement.

If you break your tenancy agreement, we can take legal action to end your tenancy.

## An Introductory Tenancy

All new tenancies for those who have not already been a Council or Housing Association tenant for the previous 12 months are introductory tenancies. The tenancy usually lasts for 12 months and during that time the tenant is effectively on probation. If there are no problems during the first 12 months, the tenancy automatically becomes secure. CBH can look to extend the introductory tenancy or take possession proceedings to recover the property if our concerns about the way in which you maintain your tenancy are more serious.

If we do need to take proceedings to recover your tenancy, the Council may not be legally obliged to offer you another social housing tenancy with us or another landlord. It is therefore very important that if you do get into any difficulties you contact your Neighbourhood Housing Officer quickly. We can then work with you to sort out any problems.

## A Non-Secure Tenancy (also known as a Part VII Tenancy)

These tenancies are granted to people who are in temporary furnished accommodation whilst being assessed by the Housing Options Team for rehousing, or who have been offered accommodation through the homeless legislation, but do not qualify for housing via the housing register. The tenancy can be ended at any time by CBH (on behalf of the Council). You will see these conditions in your tenancy agreement.

Non secure tenants may be offered an introductory tenancy with CBH or a Housing

Association tenancy if their circumstances change.

Whichever tenancy you have, we strongly recommend that you take out home contents insurance as we cannot help you if your personal items are damaged. Further information can be found on page 48 or by calling the Home Contents Insurance Team on 0800 408 0000 or 0300 555 0121.

## An Assured Tenancy / Assured Shorthold Tenancy

CBH have built and acquired properties of their own and, as they are not owned by Cheltenham Borough Council, the need to be let under different types of tenancies.

These properties are therefore let under Assured or Assured Shorthold Tenancies. These tenancies are similar to Secure and Introductory Tenancies respectively, but there are some differences, the most of which is regarding the possible purchase of your home. There is currently no Right to Buy (as CBC Secure Tenants have) but instead there is the Right to Acquire.

Like Introductory Tenancies, all new tenancies to those who have not held a Council or Housing Association tenancy for the past 12 months, will be Assured Shorthold Tenancies. These

usually last for 12 months after which they will automatically become Assured tenancies.

## A Licence

You can be offered a 'Licence to Occupy' a property if you are 16 or 17 years old and can maintain your Licence with extra support. A Licence is not a tenancy, and to maintain a Licence, a Support Officer from an agency such as P3 as well as Officers from Cheltenham Borough Homes will keep keys to the property and make arrangements to visit you on a regular basis. This is due to the type of arrangement a Licence is, and CBH can only offer accommodation to 16 and 17 year olds under these conditions.

Once the licensee becomes 18, and assuming there have been no problems with how the Licence has been maintained, then the licensee will be offered an Introductory tenancy.

**Not all tenancies have the same legal rights. If you have any questions please contact your Neighbourhood Housing Officer who can explain in more detail what rights and responsibilities you have as the tenant and what we have as the Landlord's agent in connection with your Tenancy. These rights and responsibilities are also detailed in your Tenancy Conditions.**

## Passing on your Tenancy (Succession)

A tenancy can only be handed down once. This is called a 'succession'. If you have inherited a tenancy you will not be able to pass it on. However, if the tenancy has not already been passed on, your tenancy will, in the event of your death, be passed to your spouse, son, daughter or joint tenant, if they have lived continuously at your property for the previous 12 months as it was their only or principle home.

In some circumstances a partner or other close relative may succeed to your tenancy even if you are not joint tenants. However, they must be over 16 years of age and have lived in your home continuously for at least 12 months before they can succeed your tenancy.

If you would like more information on passing on your tenancy please contact your Neighbourhood Housing Officer as this is a complex legal area.

## Giving your Tenancy to someone else

If you no longer wish to live in your home, you may be able to pass your tenancy on to someone else (as long as you are the original tenant). A deed of assignment is necessary. CBH may be able to help with this. The other person must satisfy the criteria for succession.

A tenancy can only be handed over once. If your home is not suitable for the person receiving your tenancy, we may offer them the tenancy of another home. This can happen if the home is too large or if you live in sheltered accommodation.

## Lodgers and sub-letting

If you have a spare room in your home and would like to have a lodger you can do this without our permission. If you are getting housing benefit you must tell the housing benefit office. Taking in a lodger could affect the amount of benefit you receive.

You may also be able to sublet part of your home, but you will have to get our permission first. You cannot sublet your entire home. A sublet tenant will cook all of their meals and have exclusive rights to part of your house. A lodger lives in your home as part of your household.

## Keeping Pets in Your Home

All council tenants have the right to keep a pet or pets in their home. There are restrictions as to how many pets anyone is able to keep, and tenants must ensure that the pets are housed and looked after appropriately, and do not cause any nuisance to neighbours or visitors.

Your pets must not cause any damage to either your home or any communal areas.

If you have a dog, you must keep it under control at all times, including when it is outside. You must not allow your dog to foul in public areas and you must pick up any excrement it may leave and dispose of it in a hygienic manner.

If you do not look after your pets properly and they become a nuisance, we may look to take legal action against you and your tenancy.

## If your marriage or relationship ends

If your relationship ends, you and your partner have certain rights to the family home. Both of you need to decide what will happen to your tenancy. CBH acknowledge that same sex relationships have the same rights.

## If you are married

You both have a right to the tenancy and to remain in the home. The law is quite complex and it is important that you both get independent advice about what your rights may be. A Solicitor or the Citizen's Advice Bureau will be able to help you.

Your husband or wife cannot make you leave the house until

they get a court order even if you do not have a joint tenancy. The court will look at your partner's financial situation and behaviour. It will also take into account your children's needs.

## If you are not married

The law is different. You do not have an automatic right to stay in the home unless you are a tenant. You can ask the court to give you 'occupancy rights' while matters are sorted out. The court will want to know how long you and your partner have been together and any other relevant information.

## Ending your Tenancy

If you are joint tenants wishing to end your tenancy, please contact the Empty Homes Team on 0800 408 0000 for up-to-date advice.

To end your tenancy you must give us at least four weeks notice in writing. Please ask at your area office for a termination form or download one from our website, [www.cbh.org](http://www.cbh.org).

We will need to know:

- the date you will be leaving
- your forwarding address
- a contact telephone number

On receipt of your Termination Notice we will write to confirm the tenancy end date and other arrangements with you and also provide you with a useful factsheet. Our website includes more information.

Before you leave you must:

- leave your home and garden clean and tidy
- take all furniture and rubbish with you
- make the property safe and secure
- take all your contents, carpets and curtains
- leave any fittings that belong to us
- take your meter readings for electricity, gas and water and inform your suppliers that you are moving.

Your tenancy will officially end at midnight on Sunday four weeks after we receive your written notice. You will need to hand in your keys by midday on Monday. If you fail to do this we will have to charge you extra rent which is unlikely to be covered by any Housing Benefits claim. You may be able to claim Dual Housing Benefit to cover the four week notice period so please make your own enquiries with Cheltenham Borough Council Housing Benefits Team.

CBH offers a cash bonus to tenants who leave their properties

in good condition when they end their tenancy. Please see more details on page 36.

We will charge you for any damage that has occurred during your tenancy, any non-standard items that need to be changed and any clearance required.

If you have household items that you no longer need consider donating them to local charities (they often collect) or the Council can remove them. There is a fee involved and you will be required to pay this before collection. You can make arrangements by calling the Council's Environmental Maintenance department on 01242 262626 or at [www.cheltenham.gov.uk](http://www.cheltenham.gov.uk) or email [cleansing@cheltenham.gov.uk](mailto:cleansing@cheltenham.gov.uk)

You must do this before your notice period ends.

If you leave any items in the property after you leave we will dispose of them, but you will be charged for this. Please remember that fly tipping is an offence and you may be liable to prosecution.

Please make sure that your rent account is clear when you end your tenancy. If you owe rent, please discuss this with your Housing Revenues Officer. If you cannot clear your account in full, you will be expected to make an arrangement to pay the money you owe in instalments that you can afford.

You will not normally be able to take out another tenancy with us until you have paid back the debt.

Please see page 36 for more details of our Bonus Schemes.

### If you go into nursing care or the Tenancy ends because of your death

The same rules as above will apply but:

- your next of kin or executor will need to tell us in writing
- we require 4 weeks notice to end a tenancy and the notice period will start from the Sunday after your next of kin or executor has submitted a written notice of termination to CBH.
- please be aware that your entitlement to Housing Benefit would end the Sunday following your death and the full weekly rent would be due from that date.
- any debt outstanding from the notice period would be a debt against your estate and not the personal liability of the next of kin or executor.
- if the property is returned to CBH clear and clean and free from damage CBH will credit your account with 2 weeks rent. Your next of kin or executor will need to return the keys to the area office once they have dealt with your personal possessions and cleared the property.

- if you have any further enquiries about ending your tenancy, please contact us at the area office, or telephone 0800 408 0000 and ask for The Empty Homes Team.

## TENANCY SUPPORT

Before you sign the Tenancy Agreement for your new tenancy, the Council's Housing Options Team will talk with you about any support you may need to help you maintain your tenancy.

There are a number of agencies in Cheltenham that can help with concerns you may have, from money management to accessing furniture.

Throughout your tenancy with us, you are able to request these services and we will be happy to help you with any referral, or just to offer you some advice.

Even if we are unable to provide the service you are asking about ourselves, we are likely to know how to access something elsewhere for you.

If you think we may be able to help, please contact us at the area offices and we will be happy to talk the scheme through with you.

# BONUS SCHEMES

We currently have two Bonus Schemes - these are:

- Empty Homes Bonus
- My Move

## Empty Homes Bonus

If you are planning to leave your home, whether you are transferring to another CBC property or moving to another landlord, we offer a cash bonus for every tenant who leaves their home in good condition.

The scheme rewards anyone who has been a tenant for 6 months and leaves their property clean, clear of personal items/ rubbish, without any non-standard fittings, and in general good repair. The bonus amount is related to the size of property and ranges from £100 to £190.

When CBH receives your formal notice to end your tenancy, we will send you a Bonus Scheme leaflet explaining the process.

## My Move

If you are interested in downsizing or moving to a retirement property you may qualify for our My Move Scheme. This offers advice and financial assistance to move: either by arranging and paying for removals or a one-off cash payment. In order to qualify you must have lived in your property for at least 12 months and be downsizing to a smaller property. Please contact your neighbourhood office for more information. A CBH officer will visit you at home and talk through the scheme in detail. You can be offered help with disconnection and reconnection of services to your home and also help with the cost of removals.

If you apply successfully for a My Move, you may also be able to apply for the Empty Homes Bonus when you leave your home.

# SAFEGUARDING VULNERABLE CHILDREN AND ADULTS

Safeguarding is about prevention and protection of people from abuse and harm.

CBH is well placed to help with safeguarding and assist those agencies who have a statutory responsibility to deal with it. As a landlord we provide services that take us into people's homes and therefore come into contact with children and adults who might be at risk.

We have a safeguarding policy and also working procedures for staff that give guidance on how to spot abuse and how to report their concerns. We encourage staff to talk through their concerns with our customers (unless to do so would place the adult or child at further risk of harm).

Our safeguarding Policy is available on our website.



# YOU AND YOUR HOME





# YOU AND YOUR HOME

<b>Section 1</b>	<b>Rent</b>
	Paying your rent Rent you owe Money Advice
<b>Section 2</b>	<b>Home Contents Insurance</b>
<b>Section 3</b>	<b>Moving to a new home</b>
	Transfers Mutual Exchanges
<b>Section 4</b>	<b>Buying your home</b>
	Right to Buy Right to Acquire New Build Homebuy Resales Low Cost Home Ownership
<b>Section 5</b>	<b>Sheltered Accommodation</b>
	Sheltered Accommodation Supporting People
<b>Section 6</b>	<b>Property Maintenance</b>
	Home Improvement Looking after your home Looking after communal areas
<b>Section 7</b>	<b>Repairs</b>
	Report a Repair Emergencies
<b>Section 8</b>	<b>Repairs Guide</b>
	Investing in Homes and Neighbourhoods

## Section 1

### RENT

#### RENT

Paying your rent

Rent you owe

Money Advice



# PAYING YOUR RENT

## When to pay

Your rent is payable weekly in advance and is due each Monday. You can arrange to pay monthly if you wish, but you must pay in advance for the month to come.

You will receive your rent payment card at the start of your tenancy. You should use this every time you pay your rent. If you lose your card or have queries about it, please contact your local Housing Revenues Officer who will be pleased to help.

You get four rent free weeks every year. If you have arrears, we expect you to pay on these dates to reduce them.

## How to pay

CBH tries to make it as easy as possible for you to pay your rent. Ask at your local housing office for more details of the payment methods detailed:

## You can pay by:

- direct debit
- cash
- debit card
- postal order
- cheque
- standing order through your bank or building society
- on-line at [www.cheltenham.gov.uk](http://www.cheltenham.gov.uk)
- debit card payments to your Housing Revenues Officer
- telephoning our 24 hours a day automated payment line – 0300 456 2774
- post office (for this you will require a swipe card which is available through the Finance Team 0800 408 0000)

## You can pay in person at:

Hester's Way Community Resource Centre, Cassin Drive, Cheltenham, GL51 7SU

CBH at the Oakley Community Resource Centre  
113a Clyde Crescent, Oakley Cheltenham, GL52 5QJ

Municipal Offices Cash Hall  
The Promenade, Cheltenham.

# RENT YOU OWE

If you have worries about paying your rent, or you have fallen behind with your payments, it is important that you contact your Housing Revenues Officer at the earliest opportunity. They will be able to give you advice and set up a suitable repayment arrangement.

We are here to help you and CBH also has specialist Benefit and Money Advisors who offer advice and support to help CBH customers maximise their incomes. Our Advisors also offer a benefit and budgeting advice service and may be able to help with other debts.

## What will happen if I don't pay my rent?

If you fall into arrears and do not contact us to arrange payment, your Housing Revenues Officer will contact you.

If your arrears continue to grow we may serve a Notice of Seeking Possession (or equivalent) due to a breach of your tenancy conditions. If we serve you a notice you must contact us. We can use this

Notice to take you to Court and you may lose your home.

This gives you 28 days in which to pay the money you owe or contact us so we can make a suitable arrangement with you.

If you stick to your repayment plan, you will not be evicted. If you break your repayment plan we can apply to the Court for a warrant to evict you from your home. If we take legal action because you owe rent arrears you will usually have to pay the Court costs as well as the arrears.

We will only do this if every effort to help you has failed. You have the right to appeal against this decision. If you are evicted for non-payment of rent we do not have to re-house you.

If you leave your tenancy owing rent you will be contacted at your new address to arrange payment of your outstanding debt. Failure to make adequate arrangements to pay your arrears will result in a County Court Judgment against you.

# MONEY ADVICE

CBH has its own Benefits and Money Advisor who work with tenants in our communities to help maximise their income and promote financial capability and independence. The teams aims are to pro-actively promote awareness of debt management issues and welfare benefit availability and encourage our customers to engage.

If you are having trouble paying bills or think you could be entitled to benefits that you are not receiving, they may be able to help – this service is free.

We can:

- Talk to you in private, at any of our area offices, drop-in surgeries or in your own home.
- Give you support so you can claim the benefits you are entitled to and maximise your income.
- Support you with government changes to the benefit system.
- Provide help with managing your rent account and create budget plans around your income and expenditure.

- Put you in touch with other organisations that will help you get independent debt advice
- Signpost you to support organisations and charitable and grants
- Work with you, The Department of Work and Pensions, HMRC and Cheltenham Borough Council to resolve any issues with benefit.
- Advise you on benefit reconsideration and appeals.
- Support you in accessing financial education and financial products.

To contact our Benefit and Money Advisors please call 0800 408 0000 or send an email to [bma@cbh.org](mailto:bma@cbh.org)

They also hold drop in surgeries at both our Hester's Way Resource Centre and Oakley Community Resource Centre in Whaddon. These are held every Thursday between 9am and 1pm with no appointment needed.

Please remember if you do not keep your rent payments up to date, this could affect you in the future. You may not be able to transfer your home, swap your home with another or request an approval to alter your home.

## Housing Benefit

You may be able to claim Housing Benefit to help you pay your rent. The Benefits Agency will look at your income, savings and investments, your age, any disability, number of children and other people who live in your home. They will decide whether your income is higher or lower than the amount the government says you need to live on.

It is important that you give the correct information. You will be prosecuted if you give false information.

## What if I'm in receipt of state benefits?

You should fill in a separate Council Tax and Housing Benefit form to get help with your rent. This will then be sent to Cheltenham Borough Council to work out how much you are entitled to.

## How do I know if I can claim?

You should apply for Housing Benefit if the following reflects your personal circumstances:

- you pay rent for where you live – (however if you live with a close relative and pay them rent, you cannot claim)
- you have under £16,000 in savings
- you claim state benefits from the DWP (including retirement pension and income support)
- you work, but are on a low income
- you are self employed, but are on a low income
- you are a student who meets certain criteria

If you are not sure whether you may be eligible you should make a claim and the benefit department will let you know whether you qualify.

For more information contact the Benefits Department: Cheltenham Borough Council, Municipal Offices, Promenade, Cheltenham, GL50 1PP. Telephone: 01242 264 341

## When should I make a claim?

Make your claim straight away. Any benefit due will only be paid from the Monday after your form is received. Your housing benefit cannot be backdated unless there is a very good reason.

# HOME CONTENTS INSURANCE

- are you covered?



Call us on freephone **0800 408 0000**  
for more information

## Section 2

# HOME CONTENTS INSURANCE

HOME  
CONTENTS  
INSURANCE

# HOME CONTENTS INSURANCE

Many people believe that the Council automatically insures the contents of their home. This is not the case. It is your responsibility to make sure you have insurance for the contents in your property.

The Council's insurance covers the building you live in, but not your own belongings (such as furniture, carpets, curtains and personal items). It does not cover the internal decoration of your home if it is damaged by fire, flood etc.

We can arrange for your home contents to be insured through the Council's insurance scheme.

You can pay this:

- weekly at any of the area offices,
- in the cash hall at the Municipal Offices or
- monthly in advance by bank standing order.

Your insurance needs to be kept up to date otherwise it could jeopardise any claim you wish to make.

We strongly recommend that you take out home contents insurance as we cannot help you if your personal items are damaged.

Information and application packs are available from:

## Finance Team

Cheltenham House  
Clarence Street  
Cheltenham  
GL50 3JR  
Freephone: 0800 408 0000  
Email: [financeenquiries@cbh.org](mailto:financeenquiries@cbh.org)

CBH @ Oakley Community  
Resource Centre  
Freephone: 0800 408 0000  
Email: [housing@cbh.org](mailto:housing@cbh.org)

CBH @ Hester's Way  
Community Resource Centre  
Freephone: 0800 408 0000  
Email: [housing@cbh.org](mailto:housing@cbh.org)

## Section 3

# MOVING TO A NEW HOME

## MOVING TO A NEW HOME

Transfers

Mutual Exchanges

# MOVING TO A NEW HOME

During your tenancy, you may find that your home is no longer suitable for your needs. If this happens there are various options available to you.

For further information on ending your tenancy and incentive schemes, please see pages 30–34.

## Option 1 Transfer

Properties available through Cheltenham Borough Homes are advertised every week on the Gloucestershire Homeseekerplus website. You will also find properties from other local social housing providers which may be suitable for you.

There are five steps to applying for a home with Gloucestershire Homeseeker:

- 1. Register** with Homeseekerplus by visiting the website at [www.homeseekerplus.co.uk](http://www.homeseekerplus.co.uk) and following the on screen instructions.
- 2. Banding** - Once you have been registered, you will receive a notification letter or email telling you what band you have been placed in, and what size of property you are eligible for.
- 3. View** adverts of vacant Council or Housing Association homes each week in a newsletter, available on the website or in locations across the county (full list of locations on the website).

**4. Bid** - make a note of the reference number(s) of home(s) you are interested in and place up to 3 bids per week either on the website, by phone or by text message.

**5. Offer** - After bids have closed, the property will usually be offered to the applicant in the highest band who has been waiting the longest and who meets the criteria stated in the advert.

**6.** If you do not have access to a computer you can contact the Housing Options Team on tel: 01242 775168 for assistance.

## People over 60

If you are 60 or over you may want to consider moving from your present home into Sheltered Housing. This would give you the chance to keep your independence with the extra support of an emergency intercom system (Lifeline) and the services of a Housing Support Officer.

If you are down-sizing you may be eligible for the My Move Scheme. For more details see page 36. Please discuss this with your Neighbourhood Housing Officer for more information.

## Option 2 Mutual Exchange - Homeswapper

Cheltenham Borough Homes has joined the Homeswapper service and extended this free service to all of its (secure or assured) tenants. Homeswapper is the largest national mutual exchange service for council and housing association tenants wanting to swap homes throughout the UK.

Four simple steps to swapping with Homeswapper:

1. Join online at [www.homeswapper.co.uk](http://www.homeswapper.co.uk)
2. Homeswapper automatically matches you to any potential swaps
3. Homeswapper emails or texts you with details of those matches
4. You use that information and find your new home!

Homeswapper can be used to find local and national swaps.

When you find someone to swap with, your landlord must approve the mutual exchange. Certain conditions apply.

Mutual exchanges can be refused if you or the person you want to swap with:

- has rent arrears
- is in breach of their tenancy agreement
- would be moving to a house that would be unsuitable (for example, the home is too large, too small or has medical adaptations that you or they do not need).

Contact your Neighbourhood Housing Officer for further details and to carry out the legal paperwork.

If you have difficulty accessing an on-line service, please speak to your Neighbourhood Housing Officer to find out what assistance is available.

## Section 4

# BUYING YOUR HOME

### BUYING YOUR HOME

Right to Buy

Right to Acquire

New Build Homebuy

Resales

Low Cost Home  
Ownership

# BUYING YOUR HOME

## Right to Buy

You have the Right to Buy if you are a council tenant and have held a tenancy with a public sector landlord for at least 3 years.

Some types of properties (such as sheltered flats for the elderly) may be excluded, but most other flats, bungalows and houses can be bought.

If you have been a tenant for 3 or more years (it doesn't have to be 3 years in a row) you could qualify to buy the home you currently live in. It must be your only or main home.

If you are thinking of buying your home, you can get a Right-to-Buy application form and a leaflet from your area office.

If you exercise your Right to Buy, you will get a response notice from the Council either accepting or denying your right to buy. If accepted, your home will be valued, and you will be sent an offer notice telling you the valuation of your home, the discount allowed, the sale price and the conditions of sale.

Once you have applied to buy your home, CBH will not carry out any repairs to the property that could affect the valuation, with the exception of emergency repairs.

If you would like an information leaflet and RTB application form, please call in to your area office or call 0800 408 0000.

## Right to Acquire

The Right to Acquire was introduced by the government to allow some tenants to buy their home. The Right to Acquire is only applicable to CBH built properties which qualify for the scheme.

If you apply for the Right to Acquire and your application is successful, CBH will arrange for your property to be valued by an independent, qualified surveyor. If you have the Right to Acquire, you will be entitled to a discount on buying your home from CBH.

The level of the discount is decided by the government and varies depending on which Local Authority area you live in. Unlike the Right to Buy scheme, the discount does not change depending on how long you have been a public sector tenant. The discount you are entitled to will be deducted from the market value of your home and this will be the price at which you can buy your home.

### **To qualify for the Right to Acquire you and your home need to meet the following criteria:**

- If your first public sector tenancy started before 18 January 2005, you do not have the Right to Acquire until you have been a public sector tenant for 2 years (this can be at different properties).
- If your first public sector tenancy started after 18 January 2005, you do not have the Right to Acquire until you have been a public sector tenant for 5 years (this can be at different properties).
- Your property must have been bought or built by CBH using grant given by the Housing Corporation or Local Authority on or after 1st April 1997.

If you would like an information booklet and application form, please call into your area office or call 0800 408 0000. Alternatively you can visit [www.direct.gov.uk](http://www.direct.gov.uk) for more information.

## New Build Homebuy Scheme

Housing Associations build a small number of properties for sale on a part buy, part rent basis. A typical purchase is between 25% to 75% of the market value and a reduced rent is paid to the Housing Association on the remaining share. Owners can increase their level of ownership, known as staircasing.

The Council's Housing Options Team nominate potential purchasers from the housing register when requested by the Housing Association.



## Resales

Properties that are initially bought under the New Build Homebuyer Scheme are often re-sold through the nomination process when the occupants wish to move-on and sell their home. These properties are therefore second-hand, and your purchase share can be between 35%-75%, with a reduced rent to pay on the remaining share owed to the Housing Association.

## Low cost home ownership

If you are interested in buying your own home, but you are unable to secure a full mortgage, one of the low cost home ownership schemes might be the answer. The schemes are operated in partnership with the Government, Local Housing Associations and mortgage lenders.

## Registering for Low Cost Home Ownership Schemes

If you are interested in low cost home ownership or shared ownership, register on the [Helptobuysouth.co.uk](http://Helptobuysouth.co.uk) website. All shared ownership properties are advertised here.

## Section 5

# SHELTERED ACCOMODATION

SHELTERED  
ACCOMMODATION

# SHELTERED ACCOMMODATION

## What is Sheltered Housing?

At CBH our aim is to enable our tenants in sheltered accommodation to live independently in their own homes, with access to a floating support service which is tailored to their individual assessed needs. We provide opportunities to get involved in social events within our community hubs and on individual schemes to help combat social isolation. CBH have over 500 properties available to rent, within sheltered schemes (one of which is shared ownership).

Most sheltered accommodation benefits from the following;

- Self contained studios, flats and bungalows with their own bathrooms and kitchens
- Access to communal facilities, such as lounges, lifts, gardens, kitchens, laundries and guest rooms
- Access to activities and events delivered in our community hubs
- Security doors and access to a 24 hour emergency alarm centre
- Access to a flexible Person Centered housing related support.
- Support from a locally based Housing Support Officer

CBH's housing support service is also available to older people living within our general needs properties. The aim of our support service is for it to be flexible so you can access as much or as little as you need when you need it.

Our service is here to improve your quality of life and promote good health and wellbeing. Support offered is tailored to each customer's individual needs which are assessed upon accepting a tenancy.

We understand that people value their independence and we aim to help our residents maintain this as much as possible using a variety of support mechanisms delivered in partnership with other support providers.

Upon moving in, each new resident is provided with a Sheltered Housing Welcome Pack which explains every element of living in sheltered accommodation. Please contact the Housing Support Team for a copy of this pack or for more information.

### Housing Support Team

Cheltenham Borough Homes  
Hester's Way Community  
Resource Centre,  
Cassin Drive,  
Cheltenham,  
GL51 7SU  
Tel 0800 408 0000

## Sheltered Housing Schemes

Popes Close - St Pauls

Brunswick Street - St Pauls

Dunnalley Parade and Courtenay Street - St Pauls

Gilbert Ward Court - Charlton Kings

Coopers Court - Charlton Kings

School Road - Charlton Kings

Little Herberts Close - Charlton Kings

Wallace House - Hatherley

Goldfoot House - St Marks

James Court - St Marks

Lynworth Court - Lynworth

Hanna Boote House - Lynworth

George Maisey House - Lynworth

Foster Court - Lynworth

Mendip House - Lynworth

Robert Harvey House - Town Centre

Pine Lawn - Town Centre

Watson House - Town Centre

Belmont Lodge - Town Centre

Bendall House - Town Centre

John Buck House - Town Centre

Cumming Court - Prestbury

Barlow Road - Arle

James Donovan Court - Town Centre (shared ownership scheme)

## Section 6

# PROPERTY MAINTENANCE

### PROPERTY MAINTENANCE

---

Home Improvement

---

Looking after your  
home

---

Looking after  
communal areas

---

# HOME IMPROVEMENT

## Improving your home yourself

You must obtain written permission before you change your home in any way.

You must let us know if you plan to change any of the following:

- any work on electrical, gas or water services
- structural work to walls or door ways
- fitting new doors or windows
- re-fitting bathrooms or kitchens
- installing a shower
- changing fireplaces or installing fires, or central heating
- building extensions
- sheds
- greenhouses
- garages or vehicle hard standings
- fencing
- Removing or changing any other fixtures or fittings

We will try to meet your wishes but we must have details of what you want to do before you start any work. These details need to include a written description of the work and plans proposed.

You will have to provide us with three estimates from bona fide contractors and state the reasons for choosing a particular estimate.

Only when we agree to the works being carried out can you instruct the contractor to commence. Ensure that you use a Gas Safe registered gas fitter for any work that you have done to gas appliances.

Any electrical works must be carried out by a qualified electrician.

Certain improvements may require planning permission or building control approval.

If we approve your application you have to inform us when the work will start and when it is complete. We may inspect the work at any time after commencement and when it has been finished. This is to make sure that the work is of a good standard. If we feel you need to make alterations, you will need to pay for this yourself.

All improvements or alterations you make to the property, will be your responsibility to service and maintain.

## Your right to compensation for improvements

When your tenancy is ending you may be able to claim compensation for any improvements that you have made to your home. You can apply for compensation when your tenancy ends - which is usually when you move. You cannot claim compensation if you apply to buy your home under the Right to Buy scheme.

Please contact the Technical and Investment Team for more information on your right to compensation for improvements.

# LOOKING AFTER YOUR HOME

You share the responsibility for looking after your home jointly with us.

We are responsible for most of the repairs, but you are responsible for the following:

- **Repairing deliberate or accidental damage:**

If your home is damaged by your family, including your children and pets, or by visitors, you will have to make sure the damage is properly repaired. If CBH does the work, you will be charged for it.

- **Decoration inside your home and minor repairs to woodwork and plasterwork**

- **Chimney sweeping:**

We only clean chimneys which are in use.

- **TV aerials and satellite dishes:**

We only maintain communal systems

- **Electrical fuses:**

Check the appliances you are using before you report any faults to us. The appliance may just need a new fuse.

- **Garden paths:**

We only maintain the paths that give access from public footpaths to your home and paths in your communal gardens.

- **Garden fences and gates:**

We will only repair wooden fences and gates installed by CBH which are connected to public land. Intermediate fences between properties may only be maintained with posts and strands of wire.

- **Garden shed and greenhouses:**

We will only carry out essential repairs to existing sheds that belong to Cheltenham Borough Council. We are not responsible for maintaining greenhouses.

You are also responsible for:

- Replacing plugs to bath, basin or sink
- Dishwasher/washing machine plumbing
- Installation and disconnection of cookers (gas and electric)
- Removing garden rubbish
- Changing light bulbs
- Changing batteries in smoke alarms and carbon monoxide alarms
- Replacing mirrors and toilet roll holders
- Replacing fluorescent tubes and starters
- Adapting doors to accommodate carpets
- Supplying washing lines
- Fitting extra electrical sockets
- Internal repairs to leasehold properties
- Rectifying D.I.Y. mistakes carried out by the tenant
- Clearing blockages to non shared drains where this is caused by misuse rather than a defect in the drain

You will be recharged for the cost of works undertaken by CBH where it is found that you are responsible for the work or the works are required as a result of misuse or abuse.

## House / Flat keys:

If you lose your keys to your home we can change locks and order new communal door fobs. Please note that there will be a charge for this service.

We do not keep spare keys.

If you lock your keys in your home we can gain entry but there will be a charge for this service.

You will have to provide CBH with proof of tenancy before any 'gain entry/lock changes' can be carried out. Please contact 0800 408 0000 for more information.

## Communal keys / fobs

If the fob key for your electronic security door needs replacing because it is faulty we will replace it free of charge. If you lose your fob key and need a replacement there will be a charge. To order replacement fob keys please contact your area office. You will need to provide a form of ID.

## Smoke alarms:

You must test and clean your smoke alarm regularly and replace batteries as necessary. If you do not have a mains alarm fitted please contact CBH to order one. **Remember smoke alarms save lives.**

## Alterations and Improvements

In general, we will not repair any alterations that you have made.

# LOOKING AFTER COMMUNAL AREAS

If you live in a flat or maisonette, you live closer to your neighbours than other people and probably share landings, hallways and balconies. That is why it is important that you and those around you respect communal areas and treat them well.

You have responsibility, along with the other tenants, to help keep all shared parts of your premises clean and tidy. Hallways and stairways are escape routes so in the interest of everyone's safety, please keep them free from obstructions.

We aim to ensure that all the communal areas of flats (including the gardens) are kept clean, free of rubbish and maintained to a high standard. If you live in a block of flats, it is also your responsibility to keep the area as clean and tidy as possible.

You can help by:

- not placing any items on the communal stairs or hallways
- carefully disposing of your household waste
- using recycling bins properly where appropriate
- keeping security doors closed
- reporting any repairs, damage or graffiti to us
- keeping proper control of your pets
- telling us if you are not satisfied with cleaning or grounds maintenance standards

## Refuse collection and recycling

Wheelie bins, communal bins and the refuse collection service that you receive is provided direct to you by Ubico on behalf of Cheltenham Borough Council. If you experience problems with the service please contact Ubico on 0300 300 9000.

## Removal of bulky items

If you have household items that you no longer need Ubico can remove them. There is a fee involved and you will be required to pay this before collection. You can make arrangements by calling Ubico on 0300 300 9000 for information.

If you leave any items in the property after you end your tenancy, we will collect them, but you will be charged for this. Please remember that fly tipping is an offence and you will be recharged for its removal and may be liable to prosecution.

## Estate services

### Estate Cleaning

We are responsible for the provision and maintenance of estate cleaning. This entails the cleaning of stairwells and bin stores for over 400 blocks of flats managed by CBH in the Borough.

*Service includes:*

- Cleaning of communal areas to all blocks of flats
- Clean and disinfect bin areas
- Removal of offensive graffiti
- Removal of fly tipping
- Litter pick to general areas

## Grounds maintenance

This service is provided by Ubico, but is monitored and managed by CBH.

*Service includes:*

- Grass cutting
- General maintenance to grassed areas
- General maintenance to planted areas
- Hedge trimming
- Leaf clearance (from Sheltered Housing and in heavy leaf fall areas)
- Weed killing to paved areas

## Section 7

# REPAIRS

### REPAIRS

---

[Report a Repair](#)

---

[Emergencies](#)

---



# REPORT A REPAIR

## FREEPHONE

**0800 408 0000**  
**0300 555 0121**

(local rate calls)

## EMAIL

**repairs@cbh.org**

You can call in at Hesters Way Community Centre or CBH @ Oakley Community Resource Centre and use the Freephone

## EMERGENCY

If you have an emergency repair outside CBH office hours then please call our freephone number:

**0800 408 0000**  
**0300 555 0121**

(local rate calls)

Outside office hours we can only respond to genuine emergencies.

Repairs are an important part of what we do. As an organisation, we are committed to making sure you enjoy a high quality, efficient and effective repairs service.

### Reporting a repair

It is your responsibility to report a repair to us as soon as you notice it. You can report a repair using the freephone repairs number, via email, via the customer portal and in person at your local housing office or in writing.

If you live in a sheltered scheme you can also report a repair through your Housing Support Officer.

#### Freephone:

**0800 408 0000**

**0300 555 0121 (from mobiles)**

**Email: repairs@cbh.org**

Report your repair via internet:  
[www.cbh.org](http://www.cbh.org)

The Repairs Call Centre operates Monday to Friday 8:00am to 5pm.

When you contact us to report a repair, please have this Handbook close by.

We will need to know:

- Your name
- Your address
- A contact phone number
- As much detail about the repair as possible, the repairs section in this handbook will help with this

You will be offered a date and either a morning or afternoon appointment for the repair to be carried out. Please make sure someone is home during the slot given - this helps to avoid wasted time and money. If your circumstances change after the appointment has been made please contact the Customer Contact Centre so that an alternative appointment can be made.

### Response times

We look very carefully at all repairs that are reported and give each one of them a priority rating.

## Emergencies

These are repairs that have an immediate risk to health, safety or security. In these cases we aim to get to you within two hours.

An emergency includes occasions where the health of an elderly, disabled or vulnerable person could be affected; we will seek to attend and make safe within two hours.

Emergency situations may include:

- A serious pipe leak causing major damage.
- A blockage where raw sewage is overflowing into a home.
- Electrical faults where there is a danger of fire or injury.
- A dangerous structure which could collapse.
- A front door that needs to be made safe after a break in.
- Broken glass in a front door or ground floor window (make safe only).
- No electricity supply
- No mains water supply
- Dangerous or exposed wires
- A toilet which cannot be used (if there is only one toilet in the property).
- No lights in a flat (but you are responsible for replacing fuses and bulbs).

- A heating or hot water system that has broken down in winter, or if there is an elderly or disabled person or baby in the property at other times of the year.
- An uncontrolled water burst (if cutting off the supply does not control the leak).
- A severe leak through the roof.
- Replacing a missing manhole or gully cover if it is causing a hazard.

## Urgent Repairs (done within 5 working days)

Situations may include:

- Repairing a toilet that is not flushing (if there is only one toilet in the property)
- Unblock a kitchen sink, bath or hand basin
- Replacing the rubber cone in the toilet pan
- Repairing the overflow from the toilet cistern
- Gain entry to garage doors and locks

## Routine Repairs (done within 15 working days)

This category includes:

- Replacing washers
- Repairing electrical sockets in a hall or bedroom (if there is no immediate danger)
- Replacing glass in shared areas (if there is no immediate danger)
- Repairing rotten timber flooring, stair treads or broken banister rails (if there is no immediate danger)
- Replacing kitchen cupboards and worktops
- Replacing baths, wash basins, kitchen sinks, toilet pans, and cisterns
- Replacing toilet seats
- Adjusting windows
- Replacing the cylinder jacket on a hot-water tank
- Replacing wall and floor tiles (if there is no immediate danger)
- Replacing bath panels
- Repairing shed doors or locks
- Repairing brickwork
- Repairs to inside doors, locks and handles
- Repairing cupboard doors and catches

- Repairing door numbers and letter boxes
- Repairing fences and gates (if there is no immediate danger)
- Repairing tiled surrounds on fire places
- Repairing or replacing skirting boards
- Repairing or replacing window catches
- Preventing draughts around doors
- Clearing blocked gutters

## Who repairs what?

As a general rule we are responsible for maintenance, repair and replacement of the structure of your home, together with plumbing, heating and electrical services.

It is up to you to keep your home in a reasonable condition. Your Tenancy Agreement sets out in full all the responsibilities you have for maintenance, repair or replacement. Please read it. It is your responsibility to repair or replace any damage caused through neglect, carelessness or deliberate action.

Repair	Comments	Responsibility		Priority
		CBH	You	
Adjustment to doors to clear floor covering			✓	
Any damage caused by forced entry	Made at your request		✓	
Boundary walls and fencing onto public areas	Between your home and any public area which is not open plan	✓		
Burst pipes and blockages	If caused by inappropriate use or negligence		✓	
Call alarm systems		✓		Urgent
Chimney flues in use	Sweeping when required	✓		Routine
Communal areas		✓		Routine
Door bells, latches, knobs, handles, finger plates, chains and spy-holes			✓	
Door catches, handles, hinges, shelving and drawers		✓		
Door entry phones and systems		✓		Routine
Drains, gutters and external pipes	Blockages and repairs to pre 1936 drainage is the responsibility of Severn Trent	✓		Routine
Electrical appliances	Such as cookers, fridges etc.		✓	
Electrical plugs (not sockets), fuses, resetting circuit breakers and light bulbs	But not plugs or appliances which we have not provided or adopted Bathroom and kitchen lightbulb replacement is your responsibility		✓	
External glazing and all internal glazing	Unless caused by a structural fault or vandalism		✓	

Repair	Comments	Responsibility		Priority
		CBH	You	
Fences which divide your garden from bordering gardens	Fences will be marked with a 6ft privacy panel and post and wire or chain link	✓		
Fixtures and fittings fitted by you or previous tenants	Such as shelves, curtain battens and rails, hooks, toilet roll holders etc.		✓	
Front pathways, hard standings, steps and ramps	Driveways, hard standings and driveway gates will not be maintained by CBH	✓		Routine
Garden paths	Other than to front and back doors		✓	
Gardens and dustbins	Except in a communal area		✓	
Individual television aerials, satellite dishes, radio aerials			✓	
Internal decorations and minor plaster cracks			✓	
Internal walls, skirting boards, doors and door frames, door jambs, thresholds, stairs, floors and ceilings	But not painting and decorating	✓		Routine
Keeping gullies at the bottom of a rain water downpipe clear	It is your responsibility to clear leaves and debris from open gullies Except communal gullies		✓	
Kitchen units, basins, sinks, baths, toilets, flushing systems and waste		✓		Routine
Lost or broken keys			✓	
Major internal plasterwork		✓		

Repair	Comments	Responsibility		Priority
		CBH	You	
Outside walls, outside doors, window sills, outside woodwork, window frames	Including any necessary external painting and decoration	✓		
Plugs and chains to sink, bath and wash hand basin			✓	
Plumbing to dishwashers, washing machines and other such appliances			✓	
Plumbing blockages caused by misuse	Plumbing blockages caused by misuse may be recharged		✓	Urgent
Roof		✓		
Shower heads and hoses		✓		
Other bathroom fittings			✓	
Smoke detectors	Mains smoke detectors are fitted by CBH. The replacement of batteries is your responsibility.	✓	✓	
Stair lifts	Where provided or adopted by us	✓		Urgent
Toilets, flushing systems, waste pipes		✓		Routine
Washing line posts and rotary dryers	Except in communal areas		✓	
Water heaters, boilers, fireplaces, fitted fires and radiators	Including annual servicing	✓		Routine
Water pipes and tanks, gas pipes and electrical wiring		✓		Routine

The priorities we have given in this handbook are for guidance only as each repair will be assessed individually.

Please remember – this list is not exhaustive or exclusive, telephone 0800 408 0000 for more information. If you do call us out to do a repair that is your responsibility we will recharge you for the work.

### Quality Control

We will inspect a proportion of completed repair jobs to ensure we maintain excellent standards.

You can help us achieve the highest quality by returning any 'satisfaction slips' we send you and providing feedback to the tradesperson.

You can request an inspection of repair work that you consider to be of unacceptable quality, by telephoning 0800 408 0000.

### Access to your home

You must allow access to your home. We will give you reasonable notice if we need to come into your home. We may need access to inspect, repair or improve your home or a neighbouring home.

In an emergency, we may need to enter your home without giving you notice. In these cases we will gain access in any way we can. 'Emergency' means a situation which could injure people or damage your home or a neighbouring home.

### Right to Repair

All Council tenants have a 'Right to Repair'. It ensures that any small, urgent repairs which might affect your health, safety or security are done quickly and easily.

For more information on your Right to Repair and a list of Qualifying Repairs please contact 0800 408 0000.

### Telling us what you think

Repairs are an important part of our service to you. For this reason we welcome your feedback on how your repair was dealt with - from reporting through to completion. It will help us to continually improve what we do to make sure you get the best service possible. Our trades staff are able to capture your satisfaction levels via their handheld devices (pda). Please let them know your views.

If we send a satisfaction survey to your home after your repair is done - please take the time to fill it in. You can return it to us in the freepost envelope.

# EMERGENCIES

## Fire

- Get out
- Stay out
- Call the fire brigade out
- For more fire safety advice see our Fire Safety in the Home leaflet online at [www.cbh.org](http://www.cbh.org). Hard copies available on request.

## Burst or leaking pipe

- Turn the water off at the mains
- If electrics are affected, turn off the electricity at the consumer unit.
- Call our repairs service. If our office is closed, use the emergency number

## Loss of electricity

- If neighbours are also affected, call your electricity company (check your electricity bill for the number).
- If the problem persists after following the advice on page 146, call our repairs service. If our office is closed, use the emergency number.

## If you smell gas

- Do not use the door bell
- Do not smoke
- Do not use matches or naked flames
- Open the doors and windows to get rid of the gas
- Do not turn any electrical switches on or off
- Do not use your mobile phone in the property
- Check to see if the gas has been left on unlit, or if a pilot has gone out. If so turn the appliance off, and do not try to relight it until all smell of gas has been cleared from the property
- If the leak cannot be stopped by turning off an appliance, or you are uncertain whether it has been stopped, turn the main gas supply off at the meter and phone the gas emergency service immediately:

**National Grid  
0800 111 999**

## Legionnaires' disease

CBH recognise that the risk from Legionella bacteria may arise in customer's homes.

### What is Legionnaires Disease?

Legionnaires' disease is a potentially fatal form of pneumonia which is caused by the Legionella bacteria; a common bacterium that is present in mains supplied water. The bacteria only presents a risk if it is inhaled via water based aerosol, such as that produced by a shower.

The risk is greatest when the Legionella bacteria has had time to grow. For example: water is stagnant or little used for more than 7 days AND water temperature is between 20°C and 45°C.

### What you can do to reduce Legionella risk in your new home

#### Flushing

If the water systems have not been used, or used very little, for more than a week at a time, it is important to run all the hot and cold taps at low speed continuously for a minimum of 5 minutes to flush out the stagnant water from the system.

If your home has a shower this should be run too, but importantly as showers create water aerosols it is necessary to flush them into a bag with a hole

cut into as this will capture the aerosol.

Hosepipes need to be flushed too in the same way as for showers.

#### Water Temperature

If your home has hot water storage cylinders it is important that they store the water at a temperature above 60°C.

Whilst raising water temperature is one way to control Legionella growth, it increases the risk of scalding, so please take care.

#### Other Precautions

Keep shower heads and tap spouts clean and free from limescale.

Do not change or modify the plumbing system in your property without prior consent from CBH.

If you have water storage tanks, keep them covered, insulated, clean and free of debris. Do not store anything on the top of your tanks.

#### Water System Upgrade

If your home uses hot and/or cold stored water (combi boilers do not fall into this classification) and you would like this to be changed please contact CBH.

## Carbon monoxide

Carbon monoxide kills – you can't see it, taste it or smell it.

Badly adjusted or poorly ventilated gas appliances can produce a deadly gas. This is one of the reasons why CBH undertakes gas safety checks every year to ensure that the gas appliances we are responsible for are safe. In addition CBH provides carbon monoxide detectors for every room containing a gas appliance or where solid fuel is being burned. If a carbon monoxide detector is missing or you consider one to be faulty please report this to CBH.

## Servicing/Safety Checks for Gas Appliances

CBH has a legal duty to carry out a yearly safety check of all gas appliances that we are responsible for.

You have a legal obligation to provide access to your home to allow the annual gas service/safety check to be undertaken. The majority of tenants do so, but every year some don't and legal action is promptly taken against them. They will incur all the associated Legal Costs.

At the time of the annual gas safety check, a gas safety check will also be performed on tenant owned gas fires. To do this the manufacturer's instructions will need to be referred to and in most cases this can be done using the internet. If instructions cannot be found the fire will be turned off and labelled as 'At Risk'. Please therefore keep the manufacturer's instructions for all the gas appliances that you own.

Furthermore at the time of the annual gas safety check a service will be undertaken on all gas appliance owned by CBC and a visual inspection of all gas cookers.

If you intend to install a gas appliance or have any work done to your own gas appliances you must ensure that you use a Gas Safe registered engineer.

## Asbestos

CBH recognise that asbestos presents a risk in tenant's homes.

### What is Asbestos?

Asbestos is a naturally occurring mineral that was used extensively in building materials from the 1950s onwards.

The use of asbestos was phased out from the 1980's and it is considered that since 2000 all buildings and building products are free of asbestos. If the home you are living in was built before 2000 it is likely that it contains asbestos.

### Why is Asbestos Dangerous?

Asbestos fibres and dust are potentially very dangerous if inhaled in high concentrations over a period of time. They can cause serious lung disease. The symptoms of these diseases often do not appear for 15 - 30 years after exposure to asbestos.

### Where is the asbestos in my home?

Refer to the asbestos survey summary report included as part of your tenancy information pack. If you did not receive a report please contact CBH.

The report identifies the presence of asbestos in your home; it is important that you read it and understand where the asbestos is.

The report relates only to areas of your home that were surveyed and there may be areas that were not surveyed. Some materials may not have been sampled during the survey and these will have been presumed or strongly presumed to contain asbestos where the materials are visually similar to a sampled items.

### What is the risk?

Many people have concerns about asbestos but undisturbed asbestos poses no risk to health. However, care should be taken to prevent the release of fibres.

Undertaking home improvements and repairs in your home is probably the most common way asbestos is disturbed. Therefore only undertake such work when you are sure that asbestos will not be disturbed. If you are unsure always seek advice from CBH.

### What to do if you are concerned about asbestos in your home

It is very hard to identify asbestos containing materials, but if you suspect that they are present it is best to treat suspicious materials as asbestos until proven otherwise: -

- Don't panic and leave the material alone
- Wherever possible prevent people from disturbing the material or from entering the room it is in if its located indoors.
- Contact CBH who will determine whether a material contains asbestos and how to deal with it safely.
- **Do not** attempt to remove any form of asbestos yourself.

## Section 8

# REPAIRS GUIDE









### REPAIRS GUIDE

Investing in Homes  
and Neighbourhoods



# REPAIRS GUIDE

# REPAIRS GUIDE CONTENTS

	<i>page</i>		<i>page</i>
	<b>Plumbing</b>		<b>Roofs and drains</b>
	Baths / basins 86		Roofs 132
	WC 90		Chimney 132
	Showers 94		Gutters and drains 134
	Water 96		
	Hot water 98		<b>Communal</b>
	<b>Doors and windows</b>		External / internal 138
	External / internal door 100		<b>Stairs and walls</b>
	Windows 108		External / internal stairs 140
	<b>Kitchens</b>		Walls and floors 142
	Kitchens 112		
	Sinks 115		
	<b>Heating and electrical</b>		<b>Helpful tips</b>
	Gas / electrical heating 116		Looking after your home 144
	Electrical 120		Condensation 144
	<b>External</b>		Leaking, burst or frozen pipes 145
	Garden 124		Bleeding a radiator 146
	Gates 124		Loss of electric light or power 146
	Fences 126		Controlling your central heating 148
	Garden walls 128		Clearing a blocked waste pipe 149
	Garages 128		Clearing a blocked WC 149
	Paths and steps 130		Overflows 150
			Stopcocks, gate valves etc 151

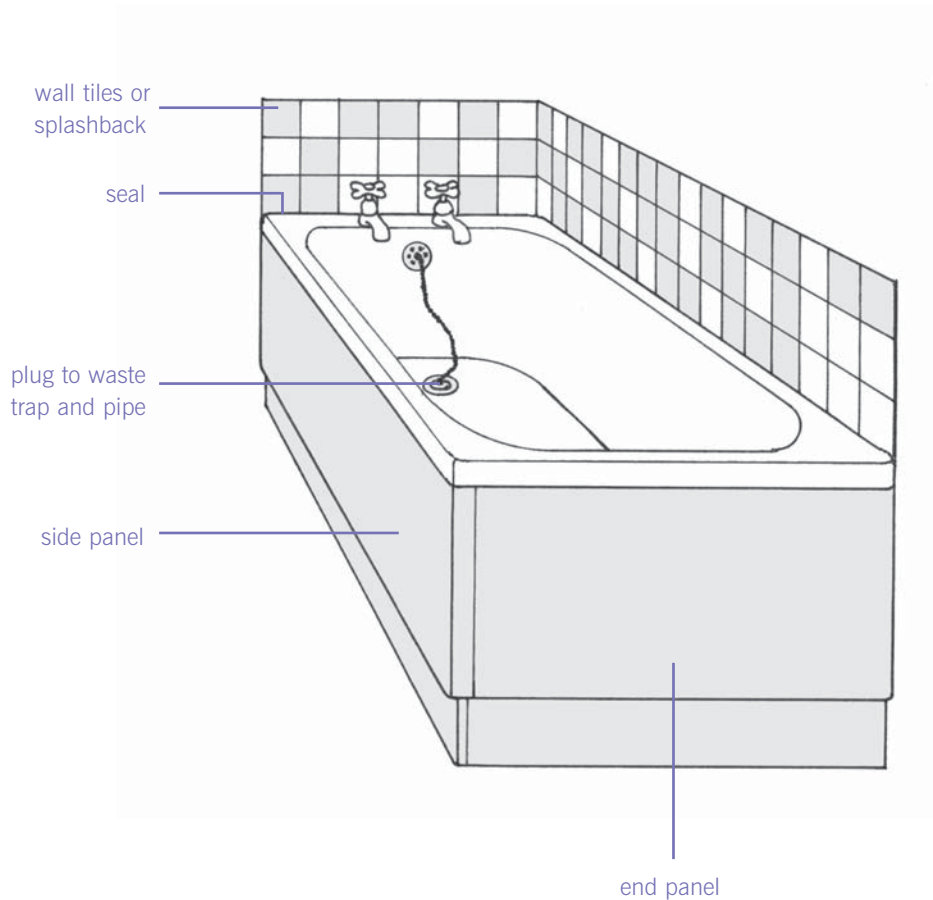

**Before you contact us:**

- If water is near electrics, do not touch. Turn electricity off at consumer unit main switch.
- Stop leak causing more damage.
- Can you clear blockage yourself? (see Tips page 149)

**Tell us:**

**Bath/basin water leaking**

- Are electrics affected?
- Where is the leak? (bath or basin)
- What is affected? (waste pipe/trap, supply pipe or tap).
- If pipework is affected, is it hot or cold supply pipe, or waste trap?

**Bath/basin blocked**

- What is blocked? (bath or basin)
- What caused the blockage?

**Bath or basin damaged/broken**

- What is damaged? (bath or basin)
- What is affected part made from? (metal, plastic or china etc)
- If a bath panel is affected, which panel (side or end panel) and what is it made from (hardboard or plastic)?
- Does it need to be replaced or refixed?

**Bath panel loose**

- Which bath panel is affected? (side or end panel)
- What is it made from? (hardboard or plastic)



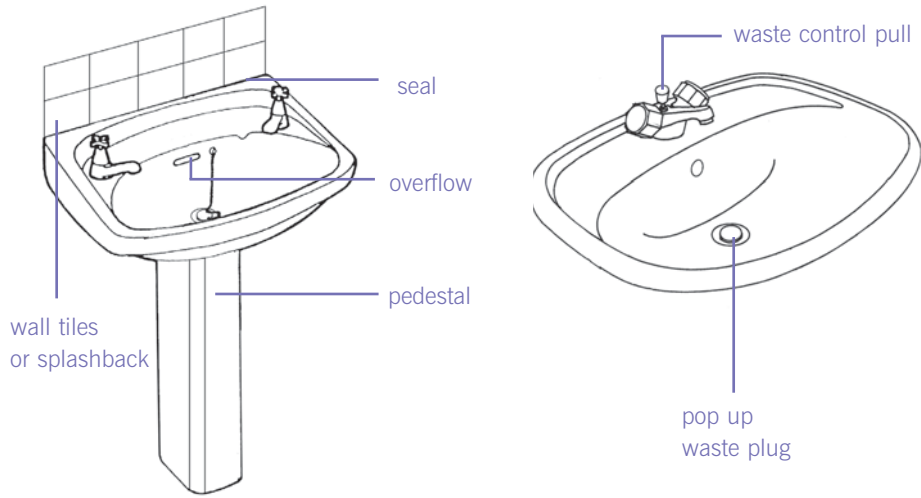

TAPS

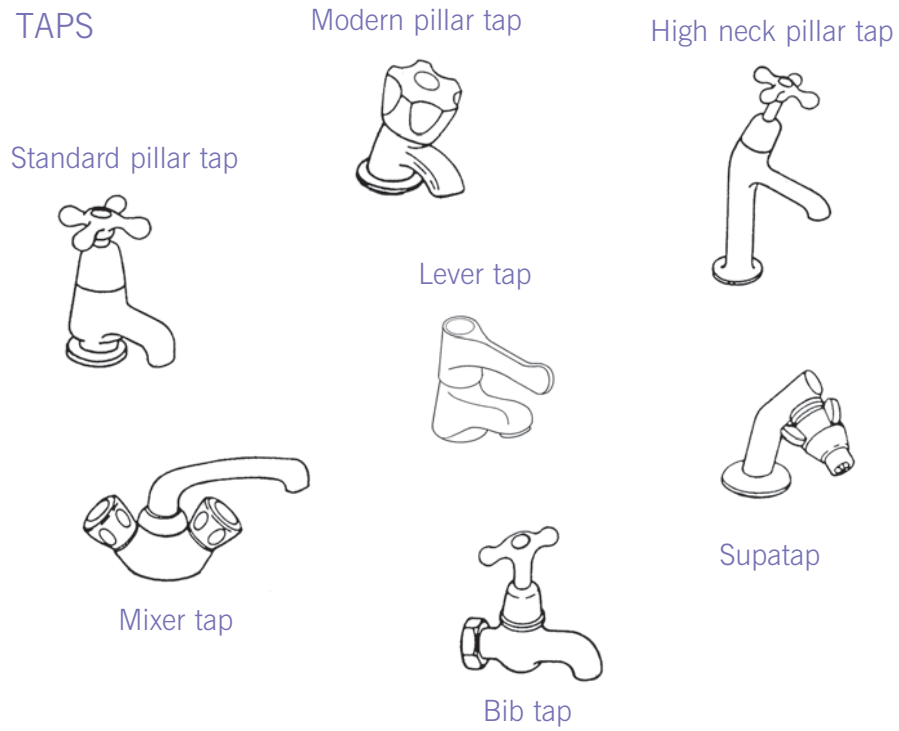

Tell us:

Damaged wall tiles

- Where are tiles?
- Are they loose, broken or damaged?
- How many are affected?
- What size and colour are they?
- How did it happen?

Seal gone around bath

Seal gone around basin

Bath tap dripping

- What type of tap is it?  
(see diagrams opposite)

Basin tap dripping

- What type of tap is it?  
(see diagrams opposite)

Basin loose

- Are brackets loose or broken?
- Is basin loose on its brackets?
- Is pedestal broken?

Tap loose

- Bath or basin tap?
- What type of tap?  
(see diagrams opposite)

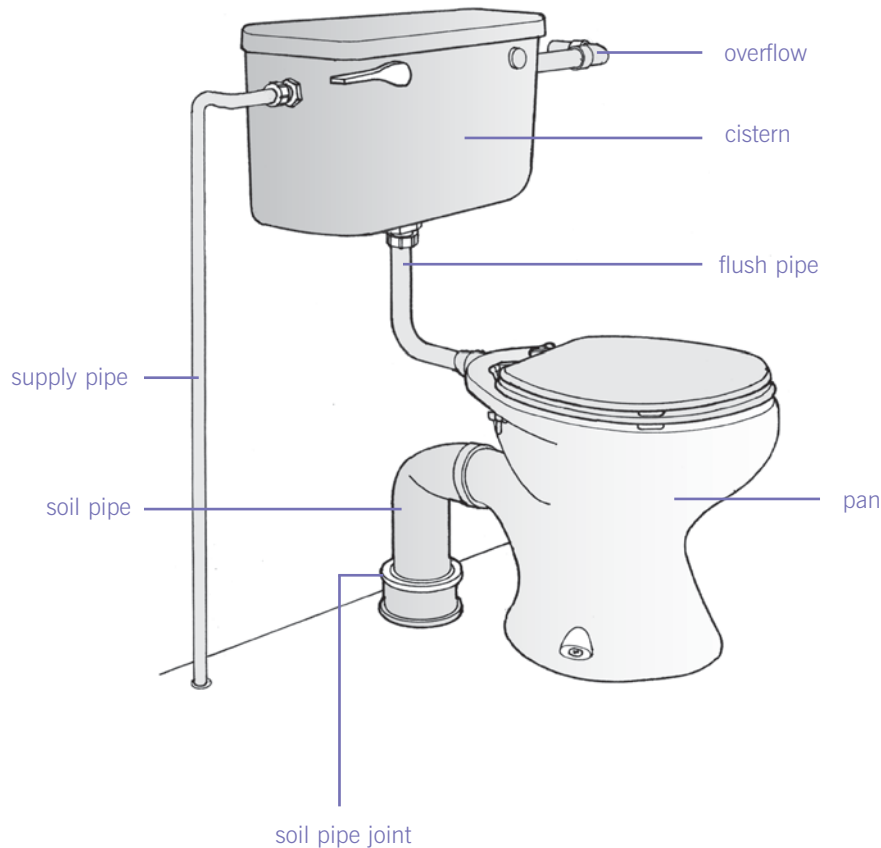
**Before you contact us:**

- Try to stop leak and any damage it is causing.
- If serious, turn off water at stopcock and gate valves from cold water tank. Open all taps to drain water from system. Turn off heaters affected.
- Has the water authority said that water would be going off?
- You can use a bucket of cold water to flush until problem is fixed.
- As a temporary solution, tie float in the up position, thus closing the ball valve (see page 150 for help).

**Tell us:****WC leaking**

- Where is the leak? (pan, cistern, overflow, supply, flush or waste pipe or pipe joint. See diagram opposite)
- If the leak is from cistern, is it high or low level cistern?
- Is affected part loose, cracked or broken?
- Is it your only WC?
- Is it a coloured WC or white?

**WC will not flush**

- Is the handle or chain moving properly?

**Overflow running**

- Does the overflow run outside?
- Is the cistern flushing?
- Is the float working?
- Is overflow running continuously?

**WC loose**

- Is pan or pipe broken?



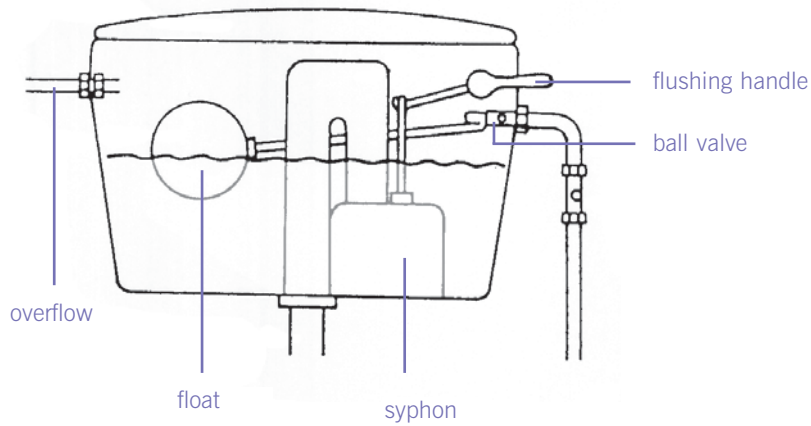

BATH / SHOWER MIXER TAP

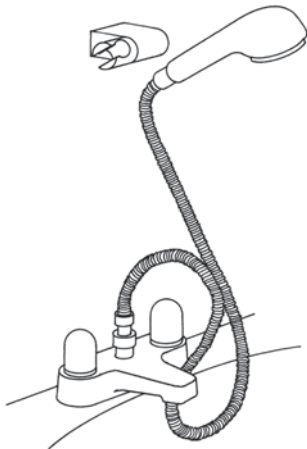

Before you contact us:

- Try unblocking it yourself by removing excess water into a bowl, and using a toilet brush or plunger (without metal disk). (See page 149 for help)

Tell us:

WC blocked

- What caused blockage?

Soil stack blocked

- Do you live in a house or flat?
- If a flat, which floor are you?
- Is your WC causing the blockage?

Seal gone around shower tray

Shower tray broken

- What is it made of? (ceramic or plastic)

Shower not working

- If it is your own shower, this is your responsibility.
- If electric, has fuse blown (see page 147).
- Are neighbours also affected by power cut?
- What type of shower is it? (eg electric, over the bath)
- What is happening? (no water, or only hot or cold water)
- Do you have hot water in rest of home?
- Can you see a make or model number on shower?

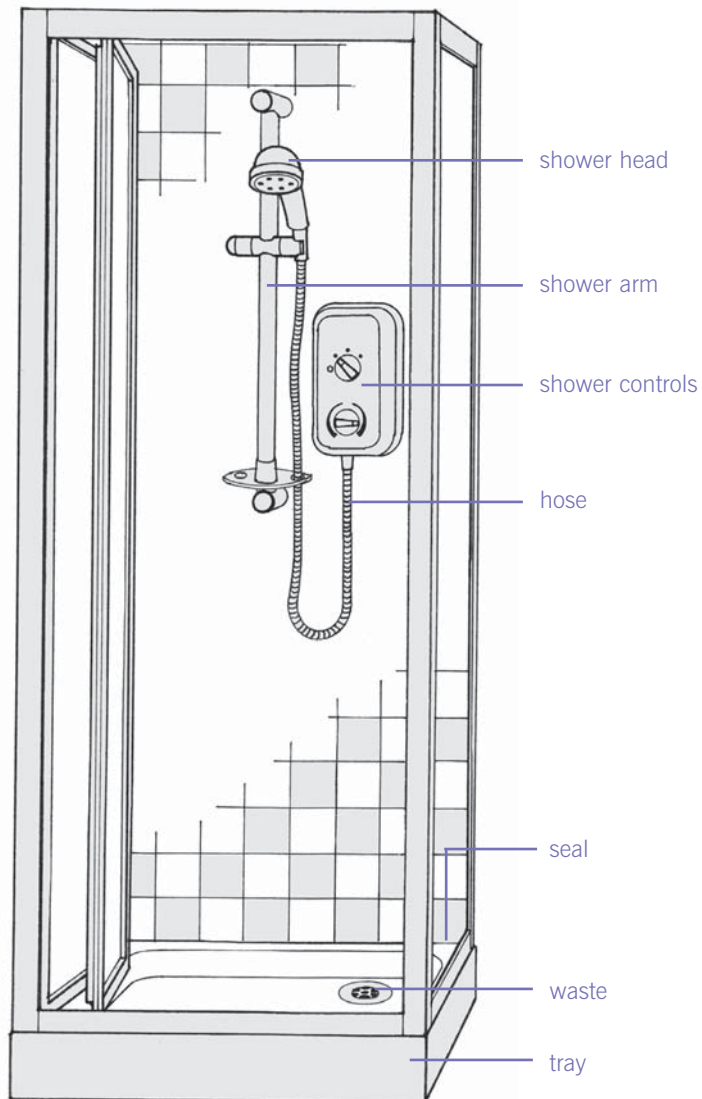

**Before you contact us:**

- If limescale is the problem, use descaler fluid which can be bought from a DIY shop.

**Tell us:**

## Shower blocked

- What is causing the blockage?

## Shower switch broken

## Shower hose broken

- How did it happen?

## Shower arm broken

- How did it happen?

## Damaged wall tiles

- Are tiles loose, broken or damaged?
- How many are affected?
- What size and colour are they?
- How did it happen?

## Cubicle door not working

- Is it broken or stuck?

## Shower tray leaking

- Has the seal around the tray gone?



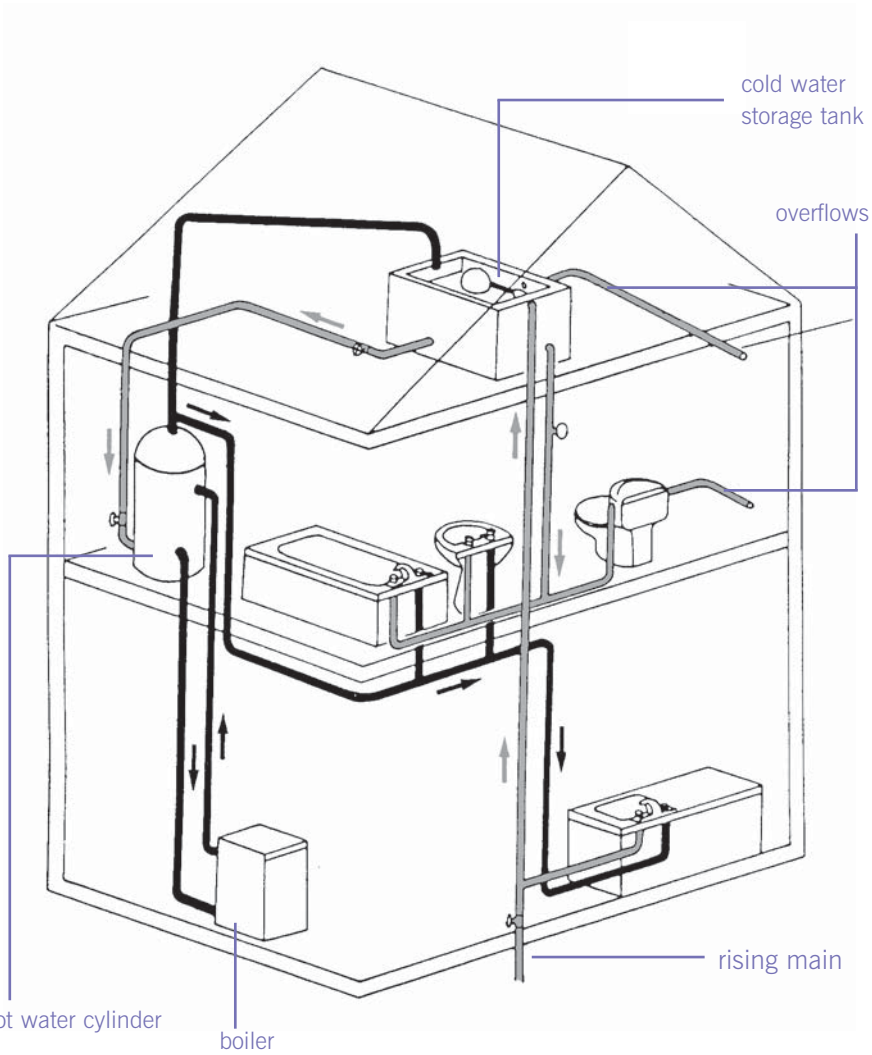

— cold water  
 — hot water



**Before you contact us:**

- If water is near electrical fittings, turn off electricity at consumer unit main switch. (See page 147)
- Can you stop leak or isolate it? Try to catch water in a bowl or bucket. (See page 145 for help)
- Adjust main stopcock where water comes into home.
- Are neighbours affected?
- Make sure taps are turned off, even though no water is coming through.

**Tell us:**

**Burst pipe**

- Are electrics affected by burst?
- Is it inside or outside building?
- Are pipes frozen?

**Water leaking**

- Is pipe, tank or cylinder leaking?
- Are electrics affected?

**Banging pipes**

- How often is it happening?

**No cold water**

- Is there cold water at kitchen sink?
- Are pipes frozen?

**Storage tank overflow running**

- Is overflow running outside?
- See page 150 for Helpful Tips



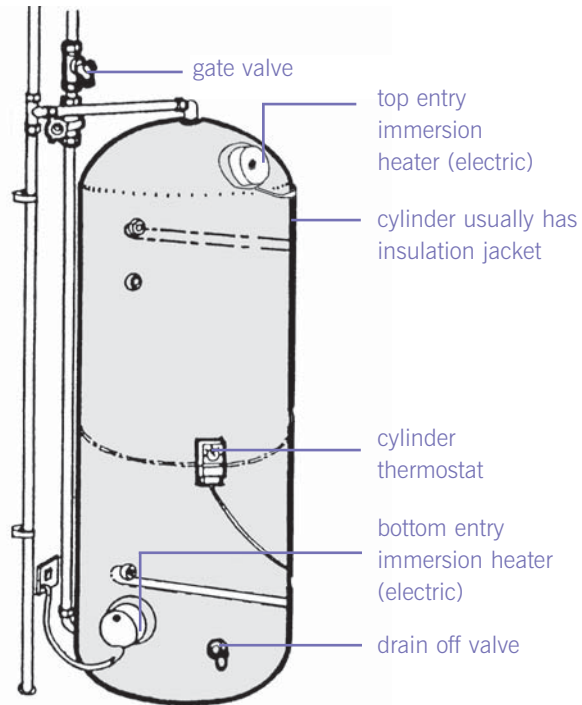
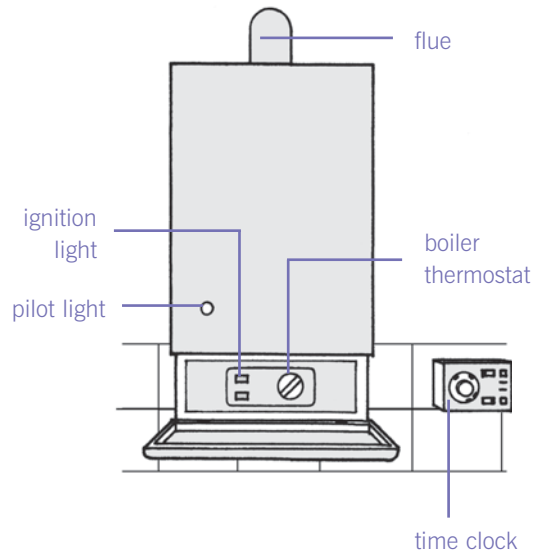

**Before you contact us:**

- If gas, check time clock controller is set for hot water and timer is set correctly.
  - If electric, is there a power cut?
  - Are neighbours affected? If so, contact your electricity company (check your electricity bill for the number).
  - If coin or credit meter, has it has run out of credit?
- 
- Adjust the thermostat on the cylinder to 55 - 60°C

**Tell us:**

No hot water

- What heats water? (gas, electric, or solid fuel)
- If electric, are other electrical facilities working?
- Are heating controls set correctly?
- Is room heating still working?
- Do you have alternative source of hot water? (immersion heater or gas heater etc)
- Do you have a hot water cylinder?

Water temperature

- Is water too hot or too cold?

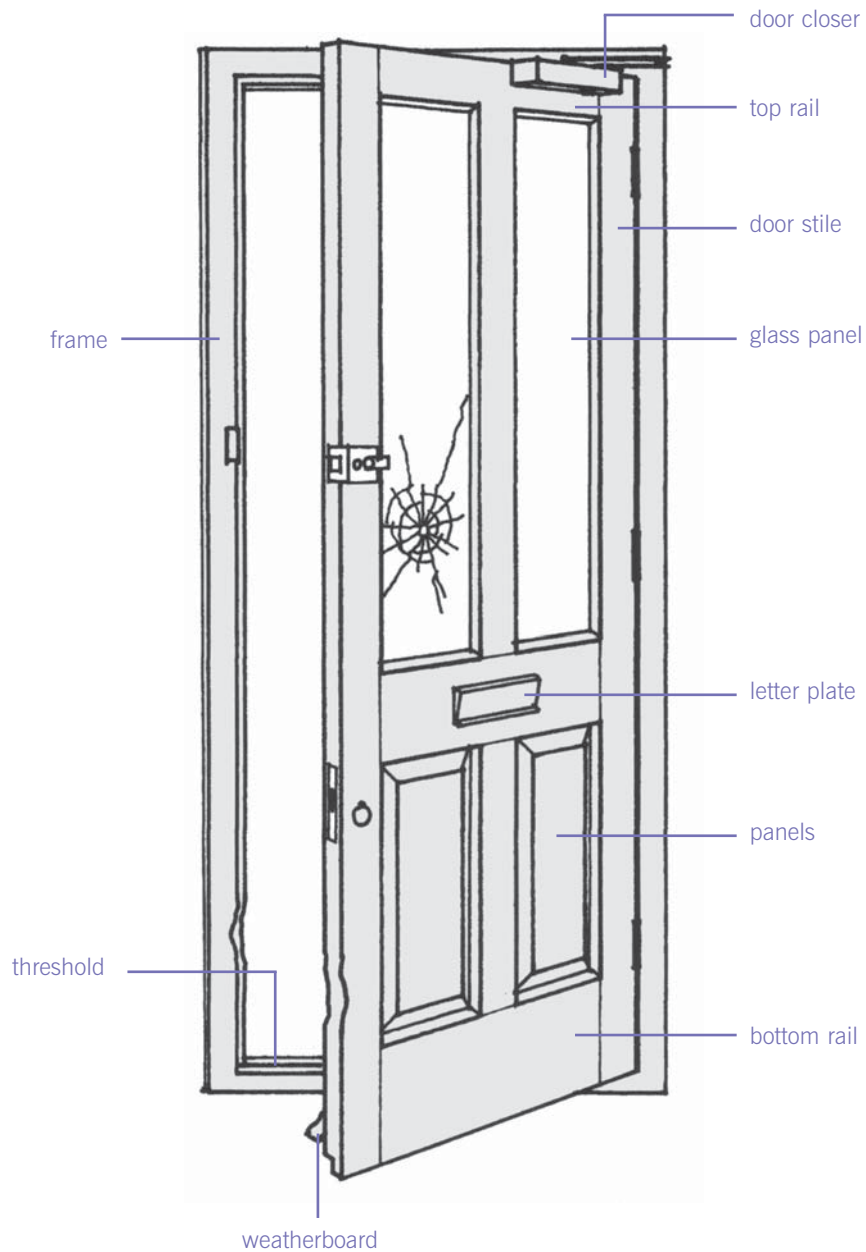

**Tell us:**

**Door jammed**

- Is it front or rear door?
- What is door made of? (wood, metal or plastic etc)
- Is door jammed open or closed?
- Can you still get in and out of your home?

**Door frame damaged/rotten**

- Is the door or the frame affected?
- Is it the front or rear door?
- What is the door made of? (wood, metal or plastic etc)
- What is wrong with it? (damaged or rotten)
- Is the home insecure as a result of this problem?

**Threshold rotten/needs repair**

- What is it made from? (wood, metal etc)
- What is wrong with it? (rotten, broken etc)

## LATCHES AND LOCKS

### Rim night latch - Yale or similar

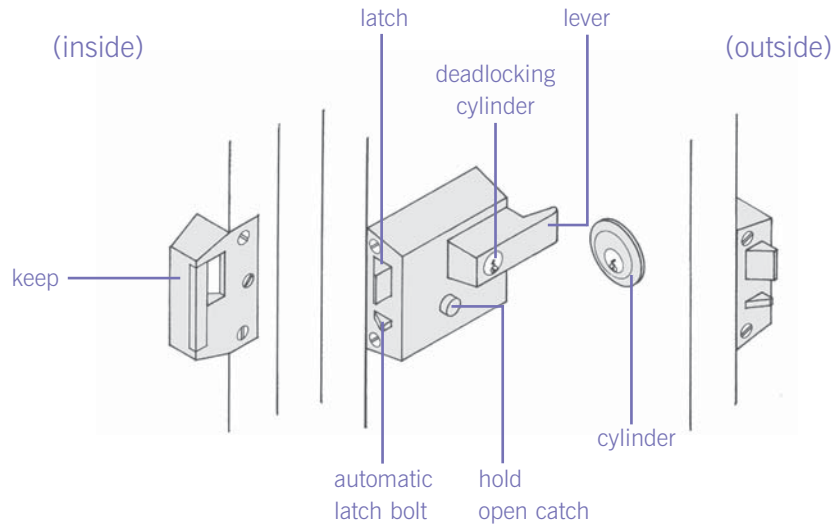

### Mortice deadlock

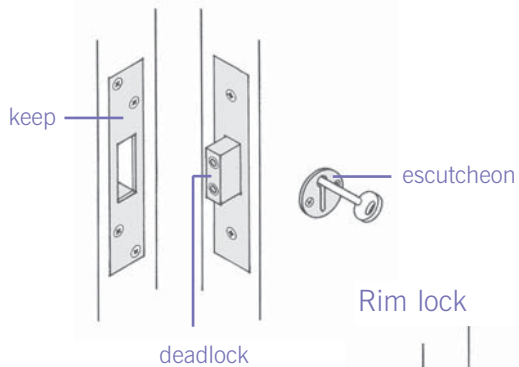

### Rim lock

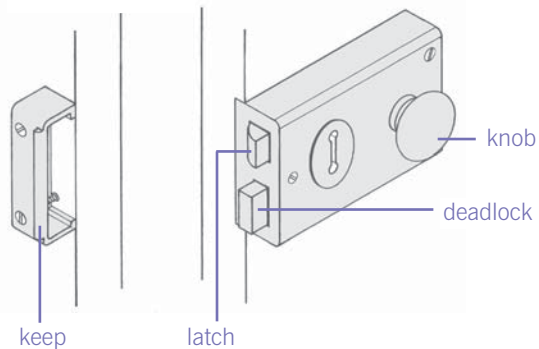

## DOORS & WINDOWS

EXTERNAL / INTERNAL DOOR



### Tell us:

#### Weatherboard rotten/broken

- What type of door is it?
- What is it made from? (wood, metal or plastic)
- What is wrong with it? (rotten, broken etc)

#### Glass damaged

- What type of door is it?
- If fully glazed, which panel(s) is damaged?
- Is it your own door or a communal one?
- Is it a front or rear door?
- Is it single or double glazed?
- What type of glass is it? (clear, wired or obscure)
- Is your home secure?

#### Draught coming around door

- Where is draught coming from? (between wall and frame, around door or under door)
- Is there any draught proofing around the door?

#### Rain coming in under door

- Does the door have a weatherboard? (See diagram on page 100)

Internal door latch

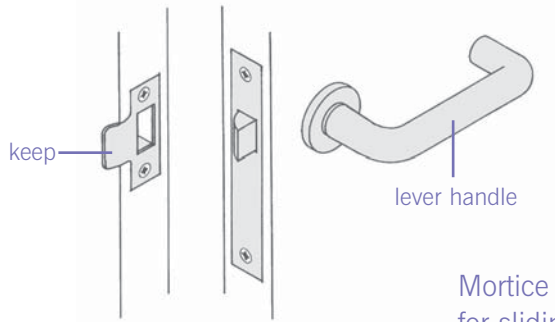

Mortice claw bolt deadlock for sliding doors

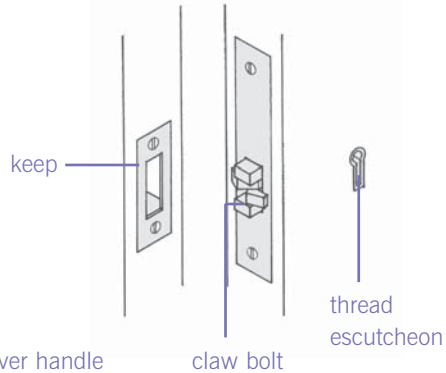

Mortice sash lock

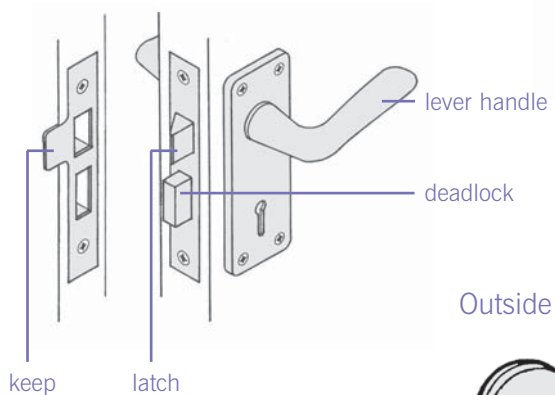

Outside door pull

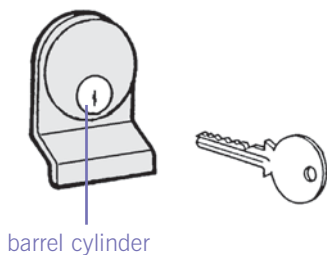

Before you contact us:

- Resident's own locks are your own responsibility.

- This is usually your own responsibility.

- Resident's own fittings are your own responsibility.

Tell us:

Door lock not working

- What type of lock is it? (See diagrams opposite)
- What is wrong with the lock? (lever handle faulty, spring worn out, striking plate out of place or lock not fitting into keep etc See diagrams opposite)
- Which door is affected?
- What is the door made of? (wood, metal or plastic)
- Is your home secure?

Keys lost/locked out

- Are you locked out of your home?
- What type of lock is it? (See diagrams opposite)
- Where is the door? (front, rear, patio or store)

Door fittings missing/not working

- What fitting is it? (letterplate, handle, chain, door viewer, house numbers etc)
- Is door not closing properly?
- Is your home insecure?

EXTERNAL / INTERNAL DOOR



## PERKO DOOR CLOSER

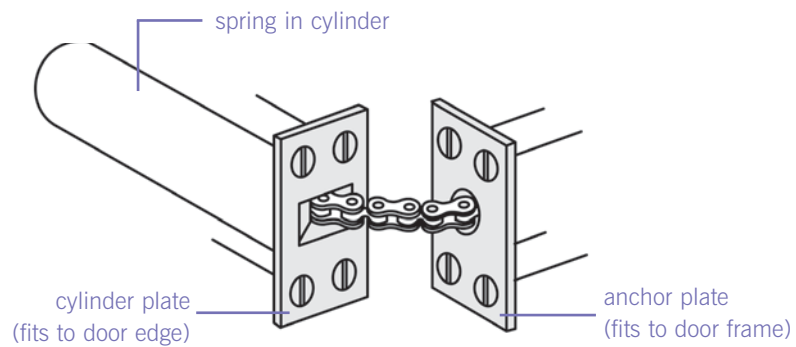

## DOOR LATCH

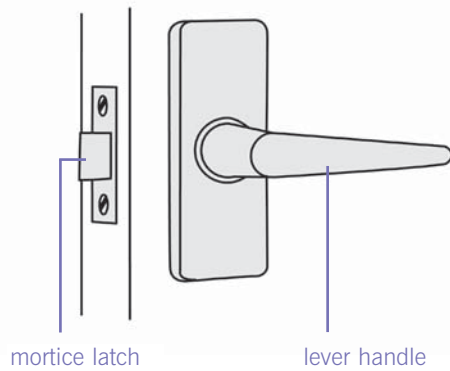

## DOORS & WINDOWS

INTERNAL DOOR



### Tell us:

#### Door sticking/jamming

- Where is the door?
- What type of door is it?  
(See diagrams opposite)
- What appears to be the problem?

#### Door damaged

- Where is the door?
- What type of door is it?  
(See diagrams opposite)
- What appears to be the problem?
- How did it happen?

#### Door latch defective

- What type of latch fitting is it?  
(See diagrams opposite and page 104)
- Where is the door?
- What is wrong with it?
- How did it happen?

## WINDOWS

Sash window

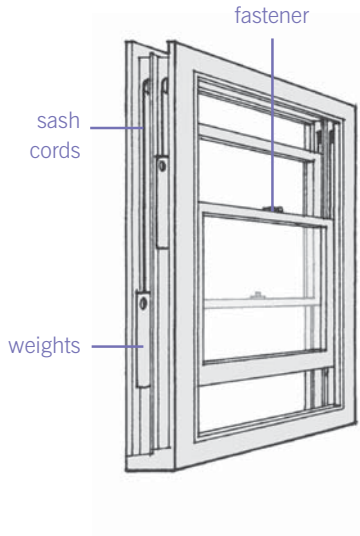

Casement window

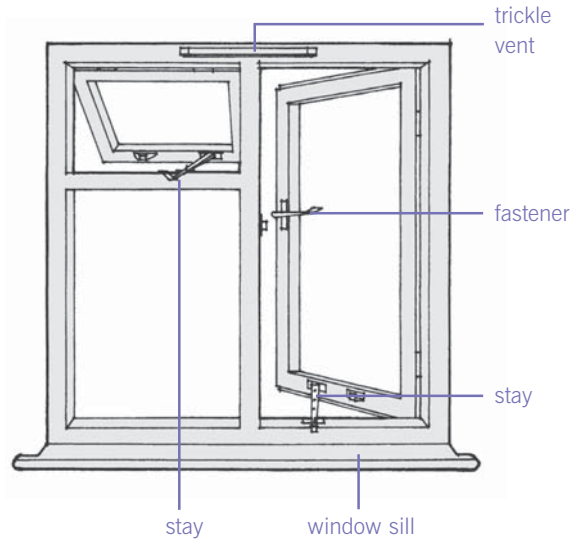

Tilt and turn window

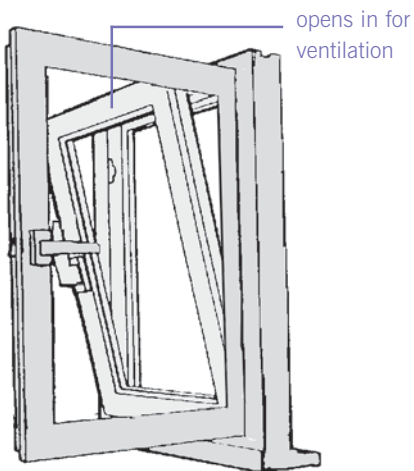

Pivot window

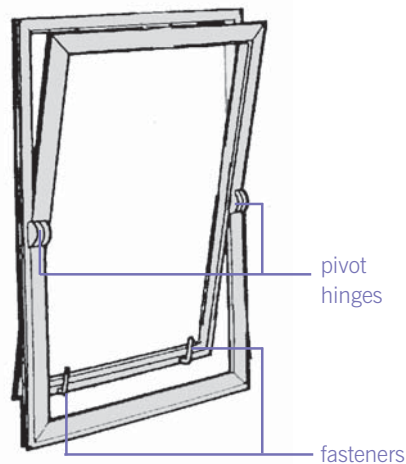

## DOORS & WINDOWS

### Before you contact us:

- If you can do it safely, remove any loose broken glass which could be dangerous to others, and wrap it in newspaper before binning it.

### Tell us:

#### Glass damaged

- Is it single or double glazed?
- Where is window? (which floor of the building, a communal window or one to your home)
- What type of glass is it? (clear, wired, or obscure)
- What is window frame made of? (wood, metal or plastic)
- Is your home secure?

#### Window frame jammed

- What is the frame made of? (wood, metal, or plastic)
- What type of window is it? (sash, casement, pivot or tilt window etc. See diagrams opposite)
- What is causing problem? (rotten wood, hinges or sash cord broken etc. See diagrams opposite)
- Is your home secure?



Fitch sash fastener

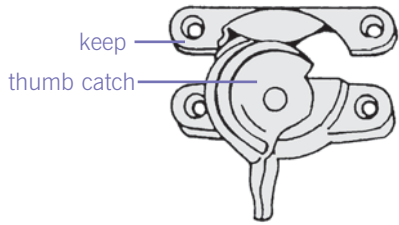

Brighton sash fastener

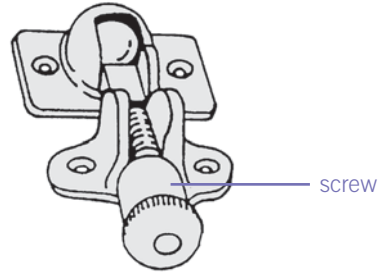

Casement fastener

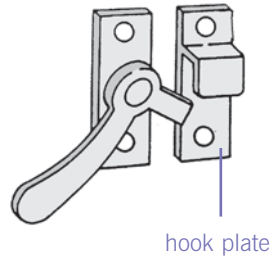

Restrictor stay  
Restricts window opening

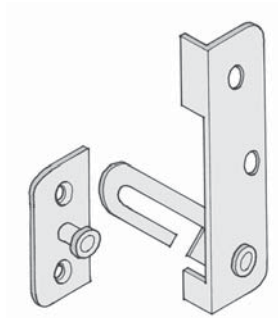

Casement stay

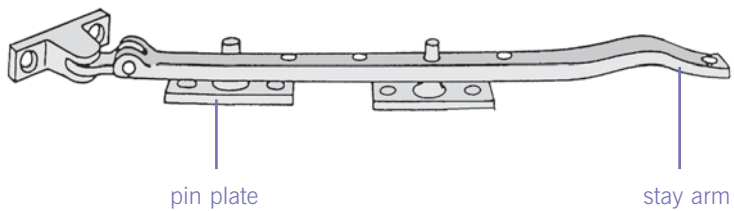

**Tell us:**

Window fittings defective

- What type of window is it? (sash, pivot or tilt window etc See diagrams page 108)
- What is the frame made of? (wood, metal or plastic)
- What part is defective? (stay, catch, fastener, lock or lift etc See diagrams opposite)
- Is your home secure?





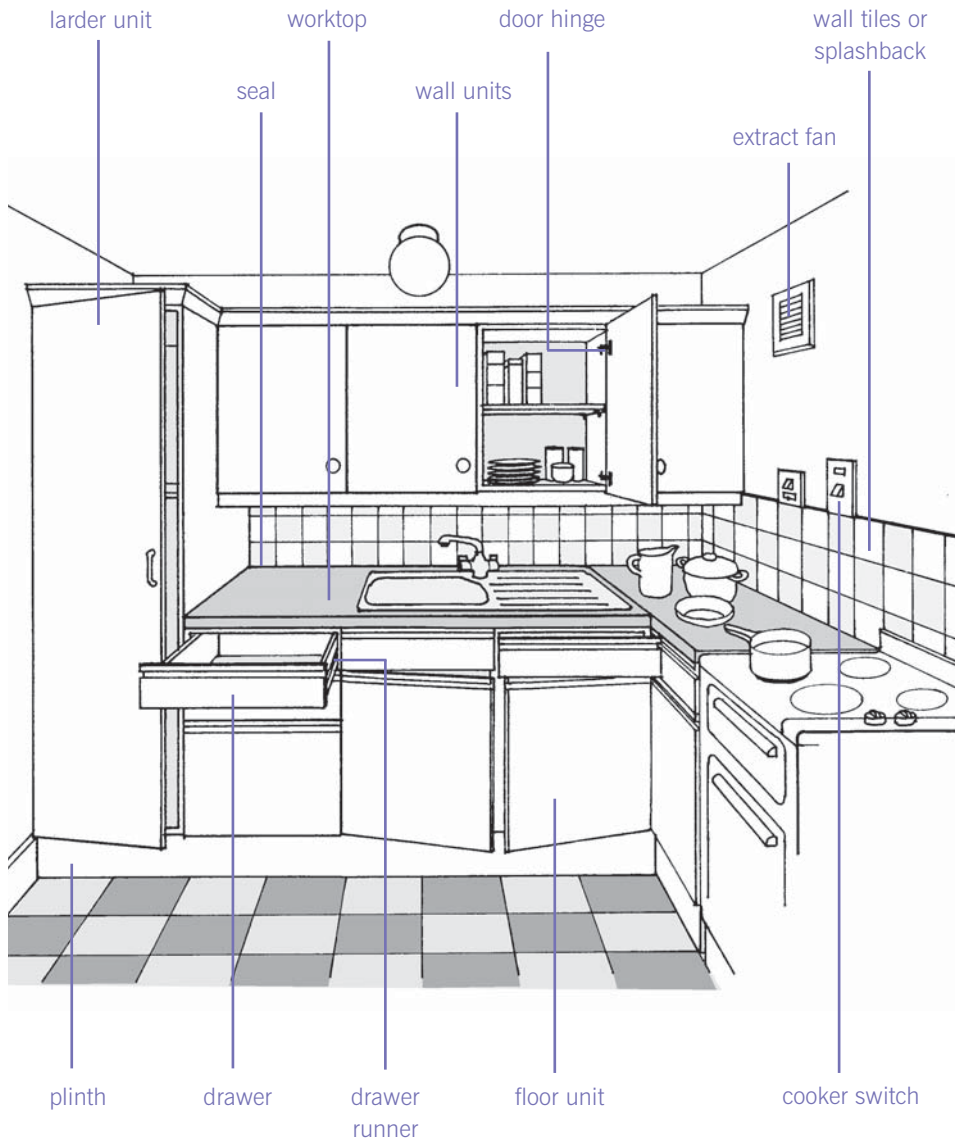

**Tell us:**

**Damaged cupboard**

- Which unit is affected?  
(a corner unit, floor or wall unit, with single or double doors)
- What part is faulty?  
(See diagram opposite)
- In what way is it damaged?
- Do you think it can be repaired or will it need to be replaced?
- What is it made of?  
(wood, plastic or metal etc)
- What colour and size is it?

**Doors and shelves**

- What part is broken (door, hinge)?
- Is shelf in kitchen unit loose or broken?
- Is shelf in wall or floor unit?

**Damaged drawer**

- Is the drawer broken or sticking?

**Worktop damaged**

- Is worktop loose or broken?
- How did damage occur?

**Damaged wall tiles**

- Where are the tiles?
- Are they broken, loose or missing?
- How many are affected?
- What size and colour are they?

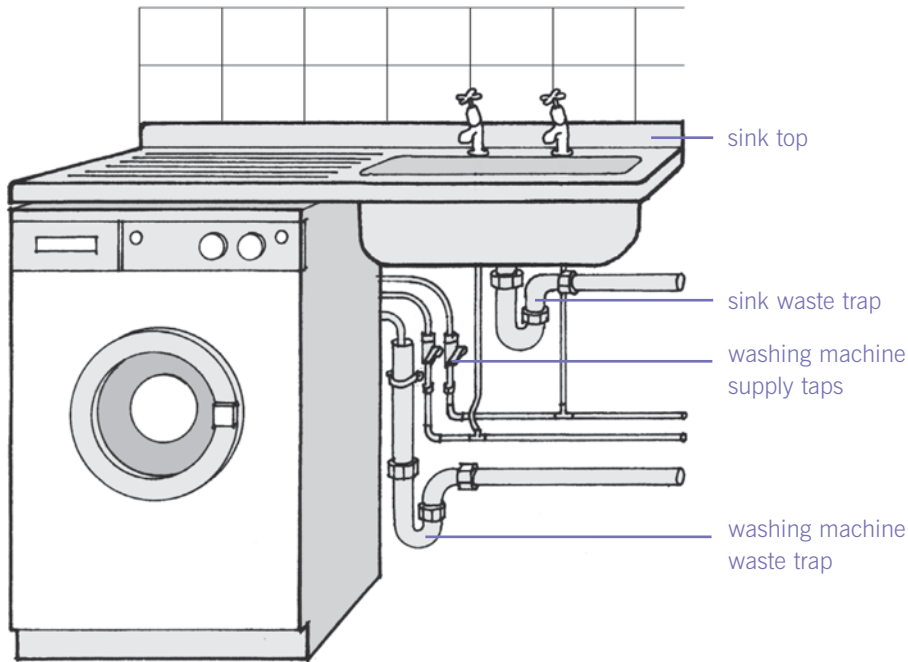

TAPS

Modern pillar tap



High neck pillar tap



Standard pillar tap



Lever tap



Mixer tap



Bib tap



Supatap



Before you contact us:

- Try to stop the leak causing more damage.
- Try to clear it yourself using a plunger. (See Helpful Tips page 149)
- Stop others using sink while blocked.

Tell us:

Washing machine blocked

- Do you know what caused the blockage?

Waste trap leaking

- What type of waste trap is it?
- Is it leaking from the joint?

Sink unit leaking

- Where is the leak coming from? (pipe, tap or waste pipe/trap. See diagram)
- What is it made of (plastic, copper)?

Sink blocked

- Are other outlets affected?
- Is washing machine blocked?
- What caused the blockage?

Seal gone around sink

Sink tap dripping

- What type of tap is it?  
(See diagrams opposite)

Sink top

- Is sink top loose or broken?
- Is entire sink unit damaged?

Tap loose

- What type of tap is it? (diagrams opposite)

## GAS BOILER

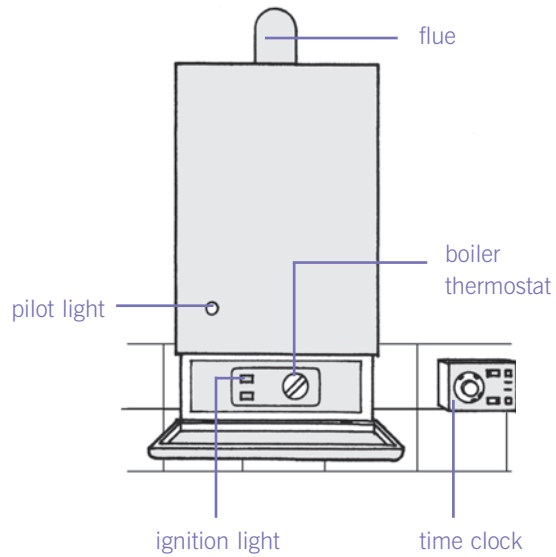

## CENTRAL HEATING PUMP

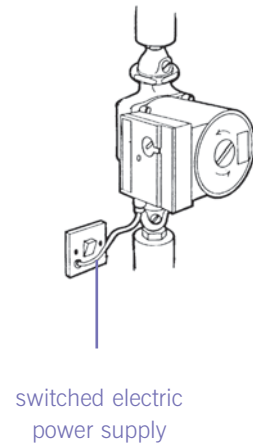

## HEATING CONTROLS

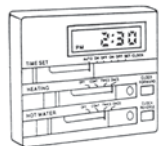

Digital programmer

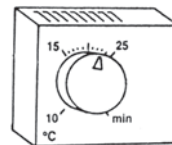

Room thermostat



Clock programmer

## HEATING AND ELECTRICAL

### Before you contact us:

- If electric, check that the power is still on, and that the meter is still in credit.
- If gas, check that the pilot light is on.
- Check that the boiler thermostat is set correctly (See diagram opposite).
- Check that the clock or digital timer is set correctly (see page 148 for help).

- Check that the room thermostat is set correctly.
- Are other flats affected?
- If you have a warden or caretaker, contact them.

- Check that the thermostatic valve is turned up enough (see diagram opposite).
- Try bleeding the radiator. (See page 146 for help)

### Tell us:

#### Central heating boiler faulty

- Is it your only source of heat?
- Do you have hot water?
- Can you see the manufacturer's name and what model it is?

#### Communal heating faulty

- Is this your only source of heat?
- Is there any hot water?

#### Radiator not heating up

- Is the thermostatic valve turned up enough?
- How many radiators are affected?
- Is the radiator warm at the bottom and cold at the top?
- Have you tried bleeding the radiator(s) affected?
- Do you have hot water?



## HEATERS AND RADIATORS

Wall mounted convector heater

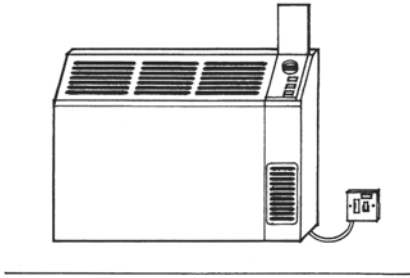

Storage heater with convector

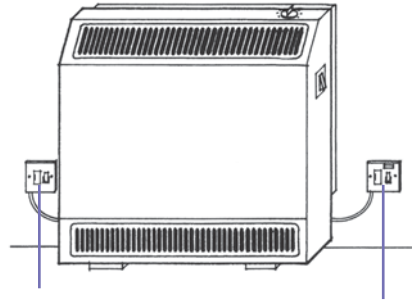

off-peak supply for storage heater

supply for convector

Panel radiator

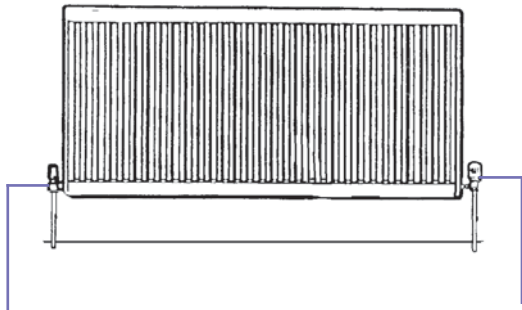

pre-set balancing valve

radiator valve (see diagrams below)

Manual radiator valve

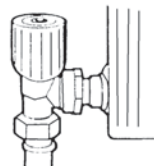

Thermostatic radiator valve

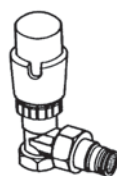

## RADIATOR VALVES

## HEATING AND ELECTRICAL

### Before you contact us:

- Try to stop the leak causing damage.
- Turn the radiator valve off.

- If there is a gas leak, do not smoke, use matches, or turn electrical switches on or off. Open windows. Follow emergency action outlined on page 80.
- Turn off any appliances that are causing fumes.

- Make sure the heater is turned on at socket.
- Check the thermostat is set correctly.
- If there is no power in rest of home, see page 146.

- Check the thermostat is set correctly.
- If faulty plug, see page 148.

### Tell us:

#### Radiator leaking

- Where is the leak coming from? (Valve, pipe joint, radiator panel. See diagrams opposite)

#### Fumes in room

- What is causing the fumes?
- Has the flue been cleaned recently?
- If the heating system is the cause, can you see the manufacturer's name and the model?

#### Storage heater defective

- How many heaters are affected?
- Where are they?
- What appears to be the problem?
- Can you see the manufacturer's name and model number?

#### Radiant/convector heater faulty

- What appears to be the problem?
- Can you see the manufacturer's name and model?



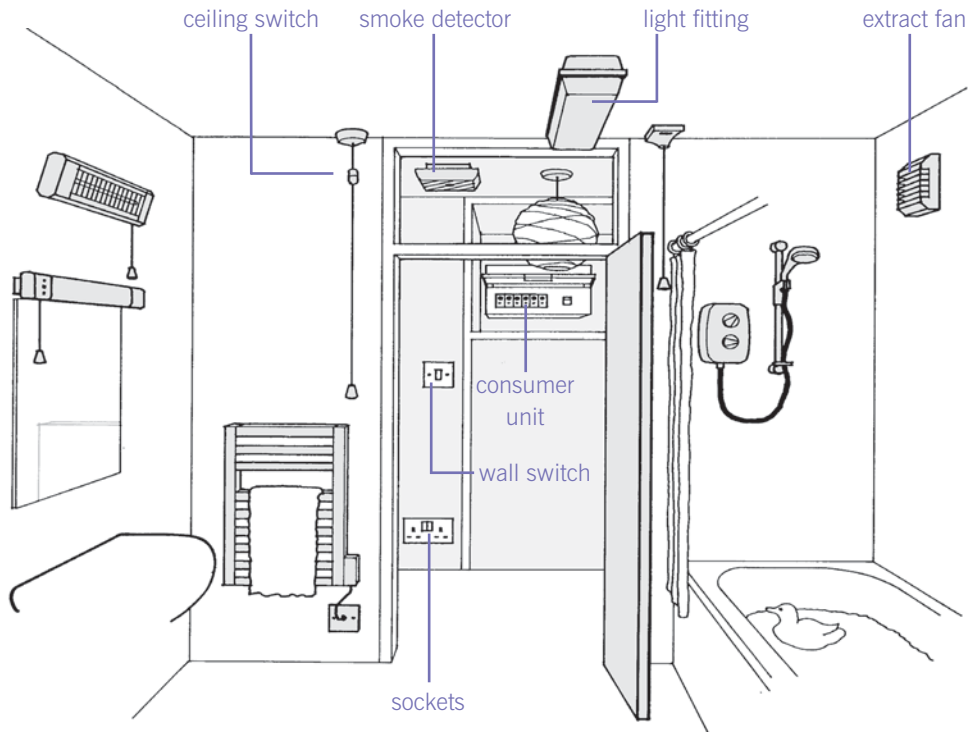

ELECTRICITY METER

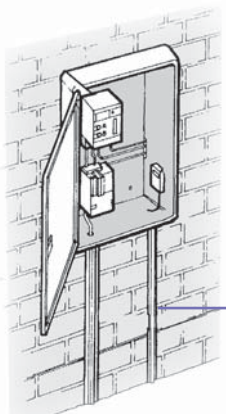

electricity supply

TRIP SWITCH

Replaces fuses in modern consumer units



Before you contact us:

- Is the fan switched on?
- If you have a coin or credit meter, check that it has credit on it.
- See if the trip switch is activated or a fuse has blown on the consumer unit.
- Are your neighbours affected? If so, contact your electricity company (check your electricity bill for the number).
- Do not touch the fitting.
- Turn electricity off at consumer unit main switch.
- See if the trip switch is activated or the fuse has blown on the consumer unit. (See page 147 for help)
- Has the bulb blown?
- Are the power sockets working?

Tell us:

Extract fan faulty

- Where is the fan?
- What type of fan is it?

No power at all

- Is yours the only property affected?
- Has the trip switch been activated or a fuse blown on the consumer unit?

Electrical fitting smoking

- What fitting is it? (light, plug etc)
- Where is it located?

Light circuit failed

- Are the power sockets working?
- How many lights are affected?
- Is the light fitting causing the problem? (the pendant, batten holder, wall or ceiling switch etc. See diagrams opposite and page 122)

Fluorescent tube not working

- What is the problem? (tube flickers, broken etc)

## PLUG SOCKETS

Single plug socket

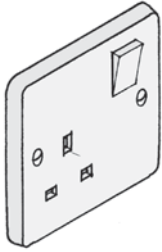

Double switched plug socket

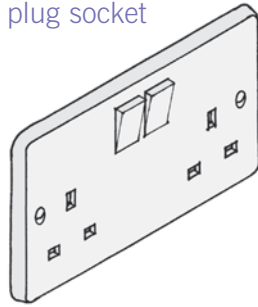

Cooker control plug socket

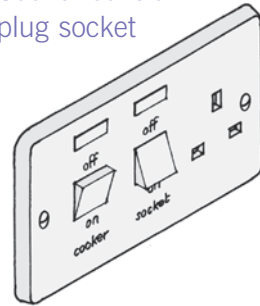

## LIGHTING

Ceiling pull switch



Pendant lamp holder

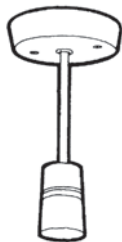

Batten lamp holders

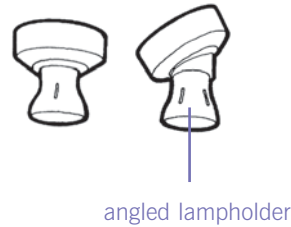

## SMOKE DETECTOR / SMOKE ALARM

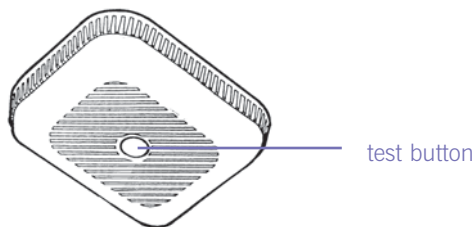

## HEATING AND ELECTRICAL

### Before you contact us:

- Is it appliance rather than power socket that is faulty?
- Is trip switch activated or a fuse blown in the consumer unit? (See page 147, for help).
- Is there no power at all in your home? If so, see page 146.

- Resident's own appliance is resident's responsibility.
- Is it power socket rather than appliance that is faulty?
- Has fuse blown in the plug? If so, renew it with a suitably rated fuse.
- Is trip switch activated or a fuse blown in the consumer unit?
- Is there no power at all in your home? If so, see page 146.

- If it is battery operated, check the batteries.
- If you have a warden, contact them.

### Tell us:

#### Plug socket not working

- Are the other power sockets working?
- Is the trip switch activated or a fuse blown in the consumer unit?

#### Appliance not working

- Are the other power sockets working?
- Is the trip switch activated or a fuse blown in the consumer unit?

#### Smoke detector defective

- Is it battery operated?
- Where is the smoke detector?
- What appears to be problem?





## GARDEN

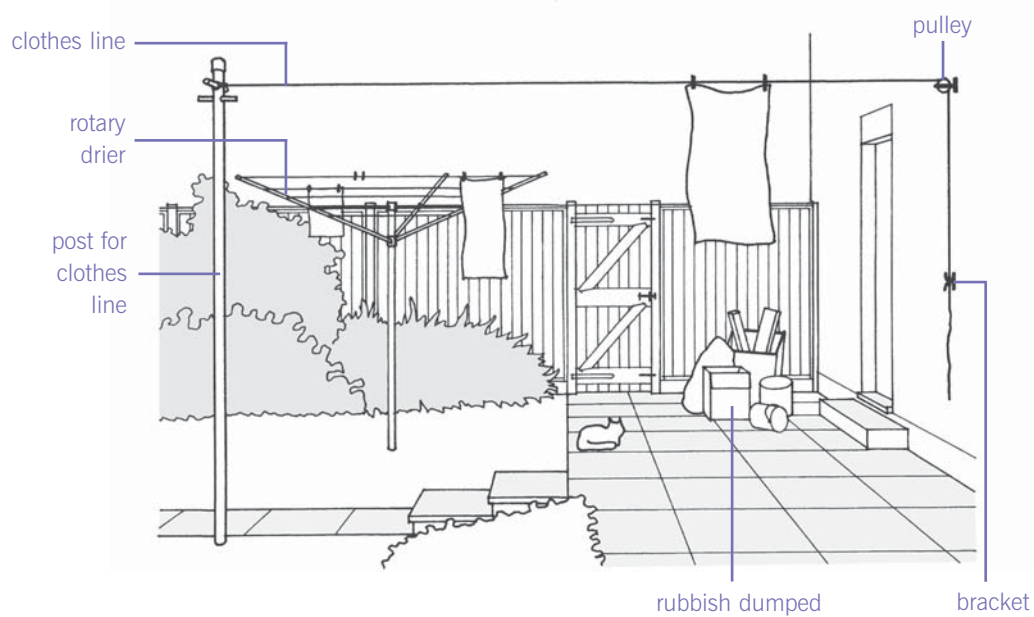

## GATES

Braced gate

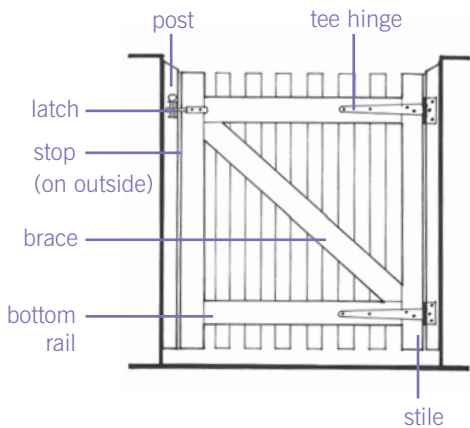

Ledged & braced gate

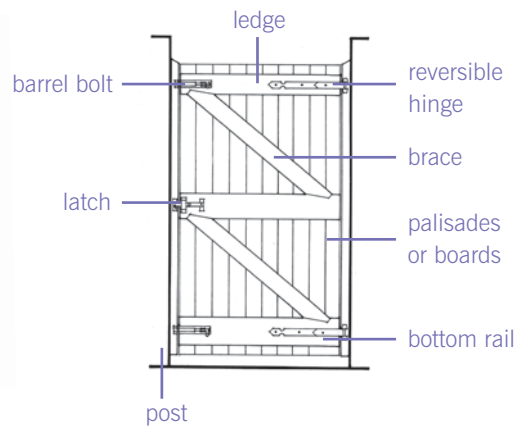

## EXTERNAL

### Before you contact us:

- Your rubbish is your responsibility

### Tell us:

#### Rubbish dumped in garden

- What sort of rubbish?
- Who put it there?
- Is it hazardous?

#### Clothes post broken

- What is it made of? (concrete or metal etc)
- How was it broken?

#### Clothes line broken

- What type of clothes line is it?
- Is the pulley or bracket broken

#### Clothes line stolen

- What type of clothes line is it?

#### Gate broken/rotten

- Where is the gate? (front, side or rear)
- What type of gate is it? (single or double etc. See diagrams opposite)
- What is gate made of? (wood or metal)
- Does it need to be replaced or resecured?
- Can work be done without you being in?

#### Gate jamming

- What is gate made of? (wood or metal)
- What is causing it to jam? (hinge broken etc.)





Palisade

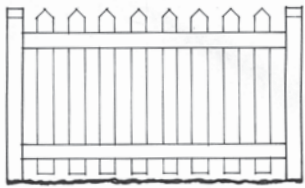

Chainlink

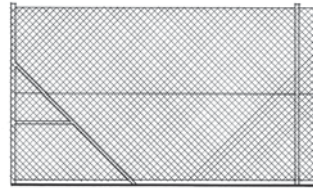

Chestnut pale

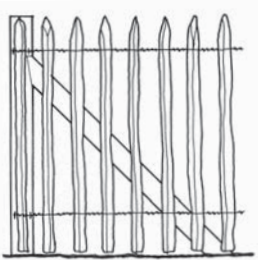

Close boarded

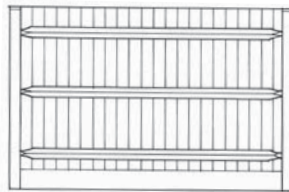

Interwoven



Hit & miss

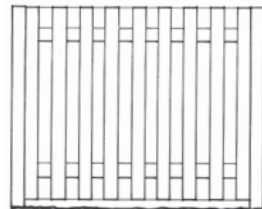

**Tell us:**

Gate latch/bolt broken

- What type of latch is it?
- What is the gate made of? (wood or metal etc)

GATES



Gate post rotten / broken

- What is the post made from? (wood or concrete etc)

Gate post stop defective

- What is the gate post stop made from? (wood or metal etc)

Fence dangerous/broken

- Where is the fence? (front, rear or side)
- What kind of fence is it? (boarded, chestnut pale, timber palisade, ranch style etc. See diagrams opposite)
- What are the posts and panels made of? (wood or concrete)
- Does it need to be replaced or resecured?
- Is it your own fence or shared with your neighbour?
- How many panels are affected or what is the length of affected fencing?
- Can work be done without you being in?

FENCES



## WALLS

Half brick wall with projecting pier

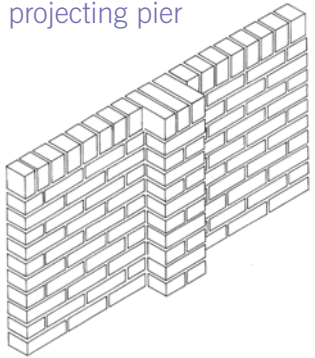

Wall with brick coping

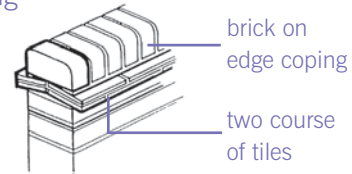

Wall with concrete or stone coping

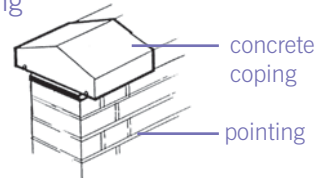

## UP AND OVER GARAGE DOOR

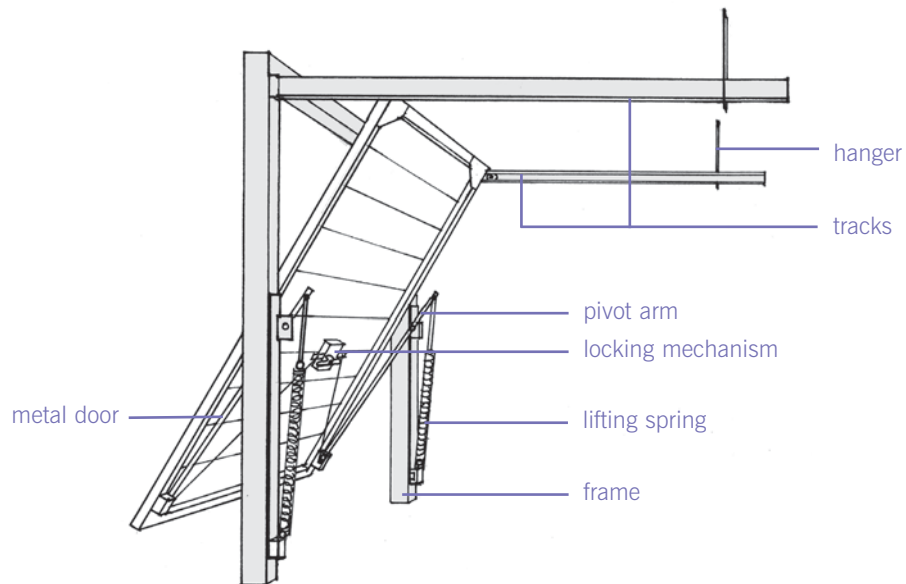

## EXTERNAL

### Tell us:

#### Wall dangerous / collapsed

- Is the wall your own, or shared with a neighbour?
- What is the wall made of? (brick or concrete etc)
- What part of the wall is damaged? (pier, coping or pointing etc. See diagrams opposite)
- What caused the damage?
- Can work be done without you being in?

#### Garage door faulty

- What type of garage door is it?
- What is the door made from? (wood, metal etc.)
- What is the problem? (door or frame is loose, damaged or off mechanism, lock is broken or keys are lost etc)

GARDEN WALLS



GARAGES



# PATHS

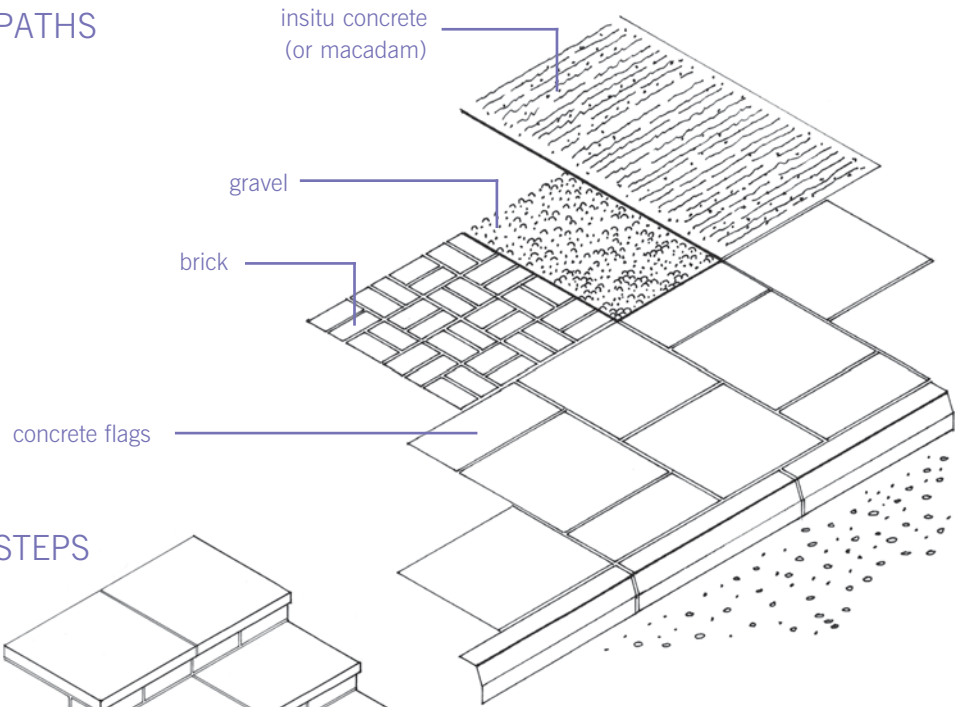

# STEPS

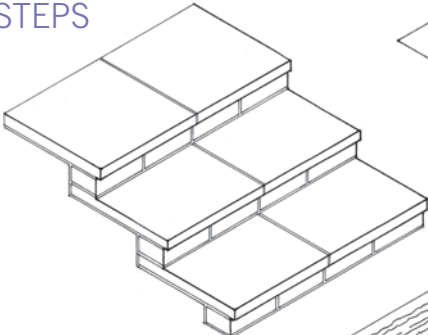

Pre cast concrete steps on brick

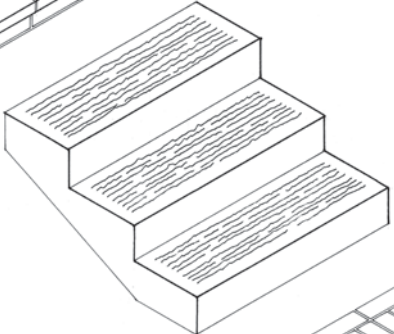

Insitu concrete steps

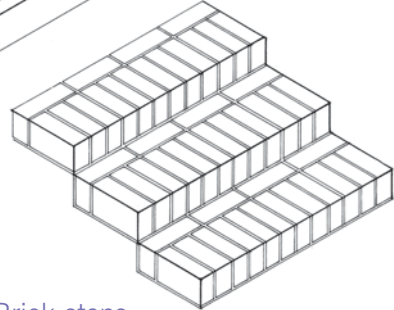

Brick steps

# EXTERNAL

PATHS & STEPS



## Before you contact us:

- If dangerous, warn others.

## Tell us:

### Paving damaged

- Where is the path? (front, rear or side)
- What type of path is it? (flag, concrete etc. See diagrams opposite)
- What is wrong with the path? (paving stones/flags are broken or loose etc)
- Does gravel path need relaying?
- Are the paving stones/flags square or rectangular?
- How many are affected?
- Is it hazardous?

### Steps broken

- If dangerous, warn others.
- Where are the steps? (front or rear)
- What are the steps made of? (concrete, brick, etc. See diagrams opposite)
- How many steps are affected?
- Is it hazardous?
- Can work be done without you being in?

## ROOFS

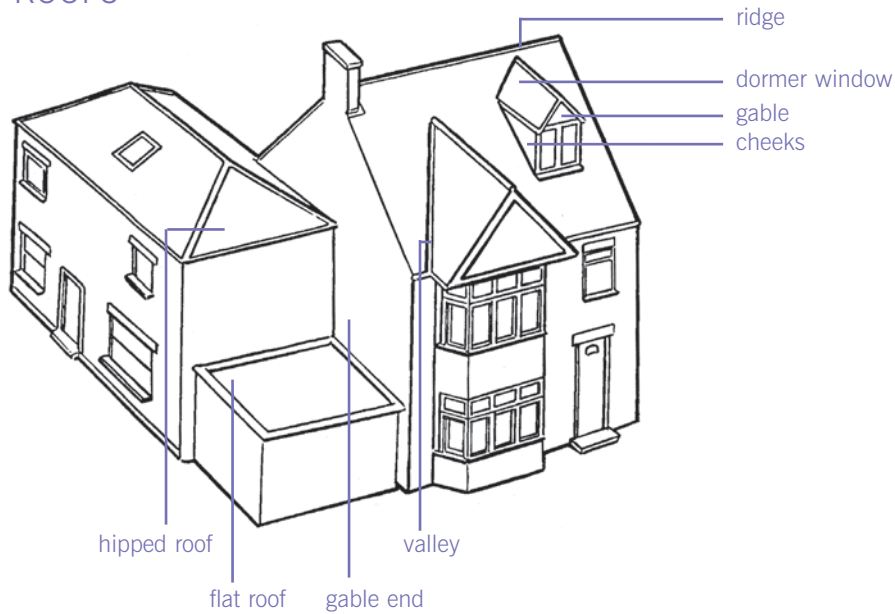

## PITCHED ROOF

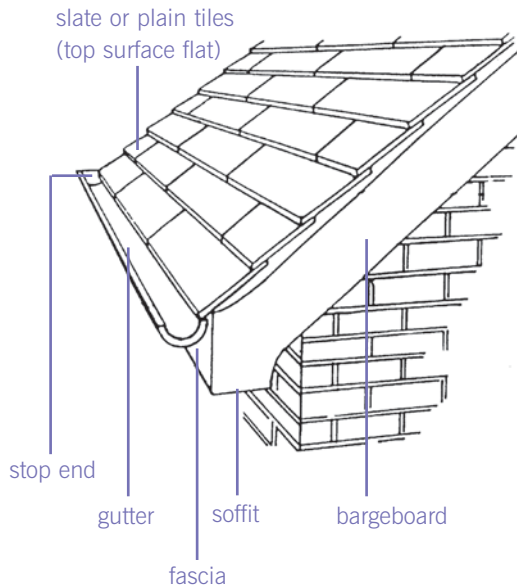

## CHIMNEY STACK

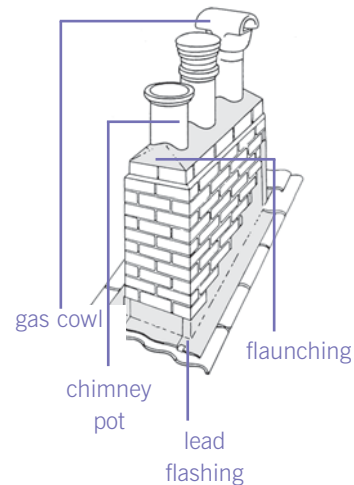

## ROOFS AND DRAINS

### Before you contact us:

- If the electrics are affected by water leakage, do not touch, and turn electricity off at the consumer unit main switch.
- If there is leakage, try to stop water causing more damage. See page 145.
- If it is dangerous, warn others.

- If the electrics are affected by water leakage, do not touch, and turn electricity off at the consumer unit main switch.
- If there is leakage, try to stop water causing more damage. See page 145.
- If it is dangerous, warn others.
- If it is dangerous, warn others.

### Tell us:

#### Tiles/slates broken

- What type of roof is it? (slate, tile etc)
- If the roof is tiled, which type of tile? (plain or interlocking. See page 136)
- Are they missing, broken or loose?
- Which part of the roof is affected? (See diagrams opposite)
- How large is the area affected?
- Is the roof leaking?
- Does it need a tarpaulin?
- Are the electrics affected?

#### Flat roof damaged

- What type of roof is it? (felt, asphalt or lead etc)
- Which part of roof is affected? (see diagrams opposite)
- How large is the affected area?
- Is the roof leaking?
- Are the electrics affected?

#### Chimney stack damaged

- Which part is affected? (stack, pot or flashing etc See diagrams opposite)
- Is it damaged, loose or missing?
- Is the chimney shared?
- Is it dangerous?

ROOFS



CHIMNEY



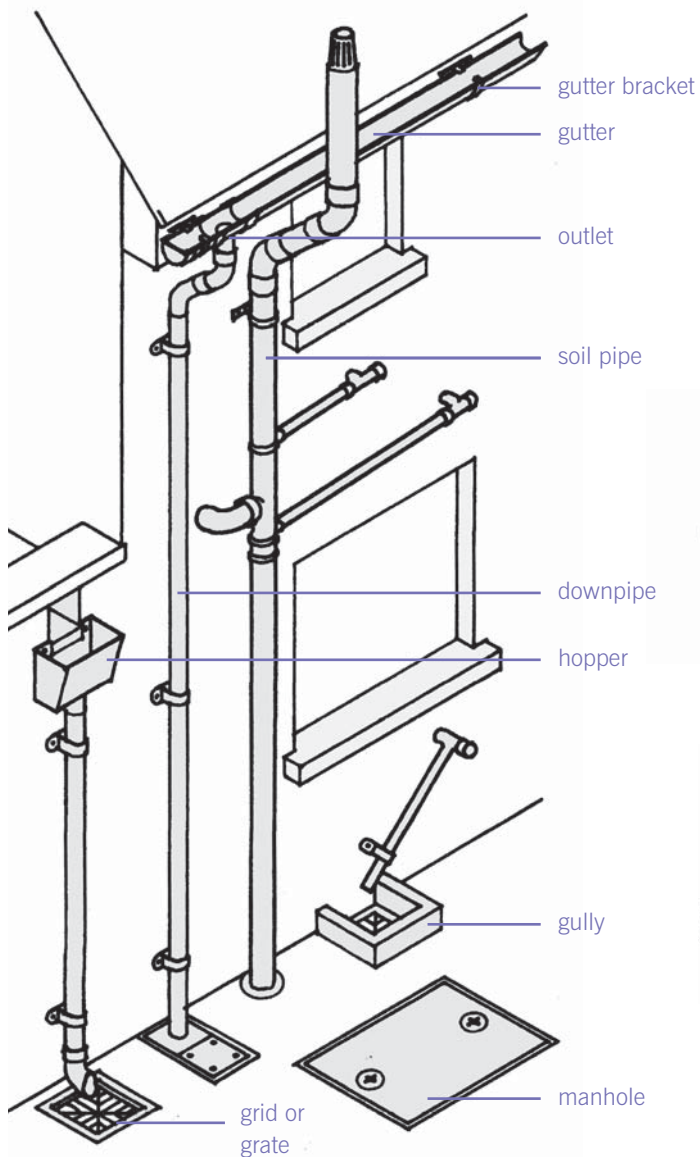

GULLIES

Back inlet gully

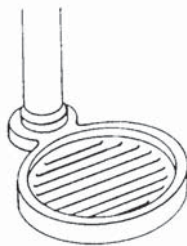

Open gully

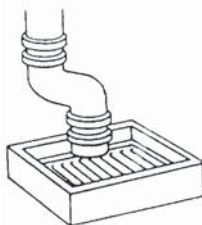

Before you contact us:

- If dangerous, put something over it to alert others to the danger.

Tell us:

Manhole cover defective

- Where is it?
- What is the problem? (loose, broken or missing)
- Is the frame damaged?
- Is it dangerous?

Manhole overflowing

- Where is it located?

Gully cover defective

- Where is it?
- What is the problem? (loose, broken or missing)
- Do you think it can be refixed or does it need to be replaced?
- What is it made of?
- What size is it?

Gutter overflowing

- Where is the overflow coming from? (gutter, hopper, pipe etc. See diagram opposite)

Gully blocked

- What is blocking the gully?

Drains blocked

- What is blocking the drain?
- Is the soil pipe blocked?

- Try to clear any leaves or other rubbish yourself with a stick.

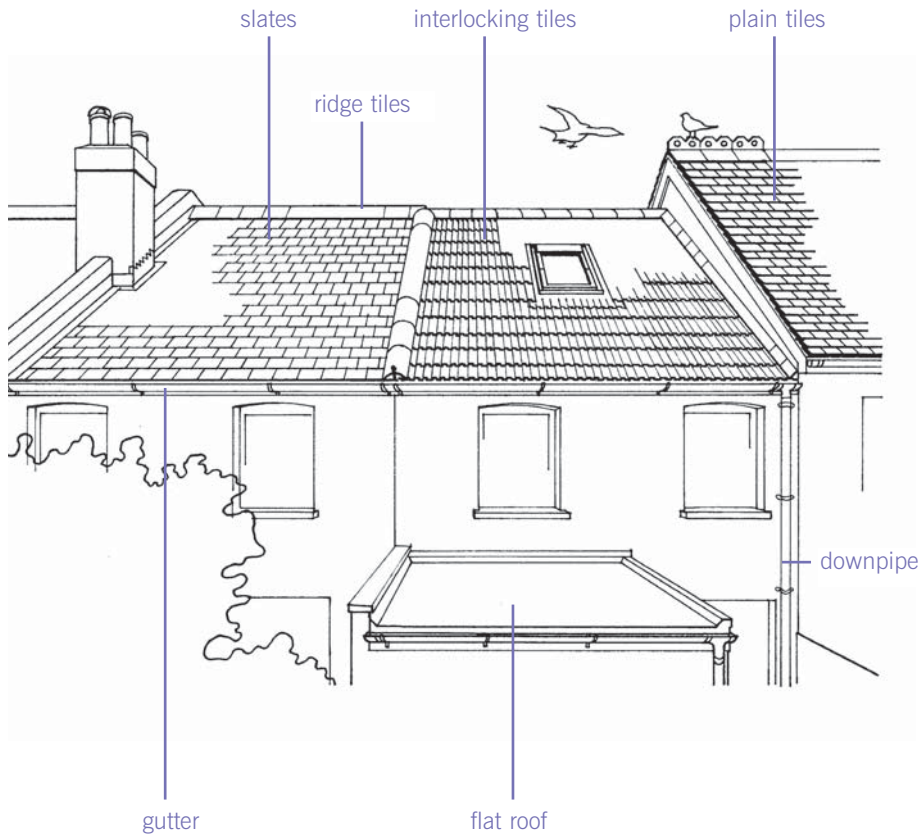

**Tell us:**

Guttering/downpipe defective

- What is affected?  
(gutter or downpipe. See diagrams opposite and page 134)
- What is the problem?  
(guttering or downpipe is blocked, cracked, loose etc)
- If it is leaking, can you tell where from?  
(joint, hopper or pipe etc. See diagram page 134)
- What is it made of? (metal, plastic etc)
- Can it be refixed or does it need to be replaced?



## EXTERNAL COMMUNAL FACILITIES

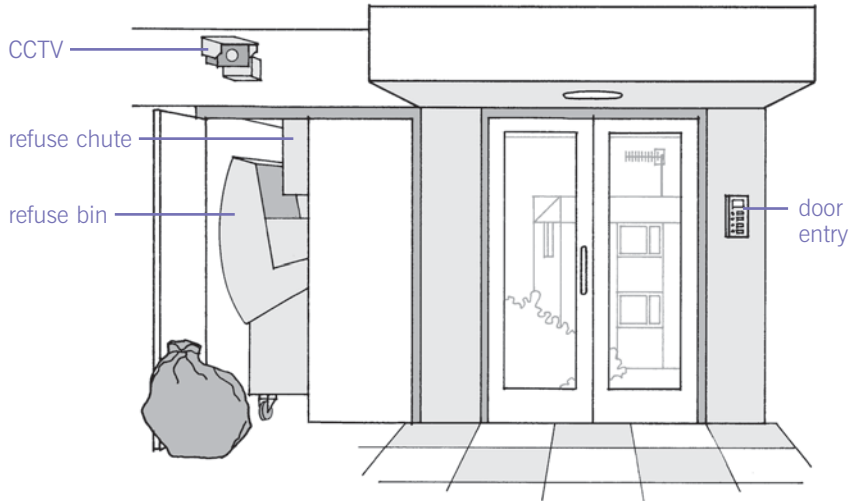

## INTERNAL COMMUNAL FACILITIES

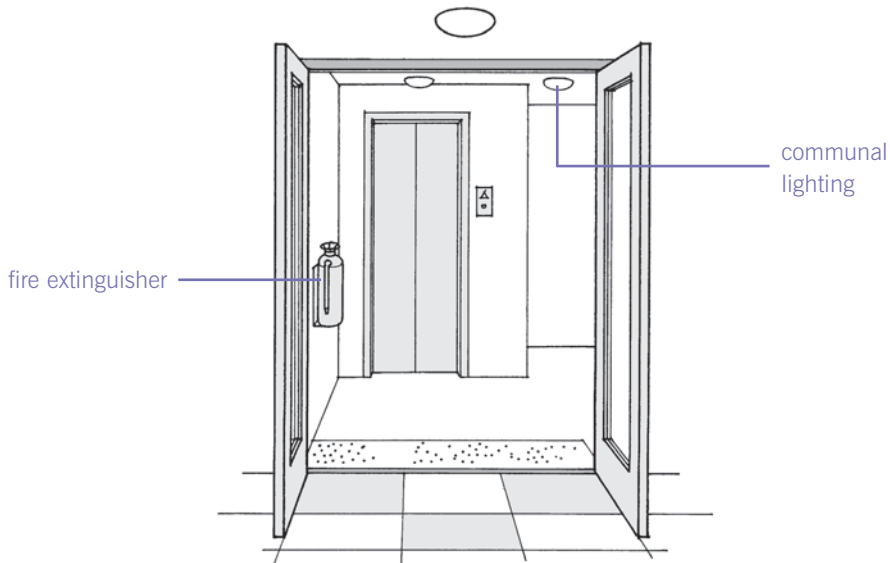

## COMMUNAL

### Before you contact us:

- If the door is jammed, see page 101 and page 107.
- Is the power cut causing the problem? If so, contact the electricity company.

### Tell us:

#### Door entry faulty

- Has the whole system failed, or is only your home affected?
- Is the fault at entrance or your phone?
- Is the door jammed?

#### Emergency lighting faulty

- Which lights are affected?
- Is it failing to turn off or not coming on?

#### Communal lighting faulty

- Which lights are affected?
- Is it on all the time?
- Does it not come on at all?

#### Rubbish chute faulty

- What is wrong?  
(chute is blocked, broken etc)

#### Services

- Is the fire alarm ringing?
- Is the CCTV faulty?
- Is there a problem with the communal TV aerial?

EXTERNAL / INTERNAL





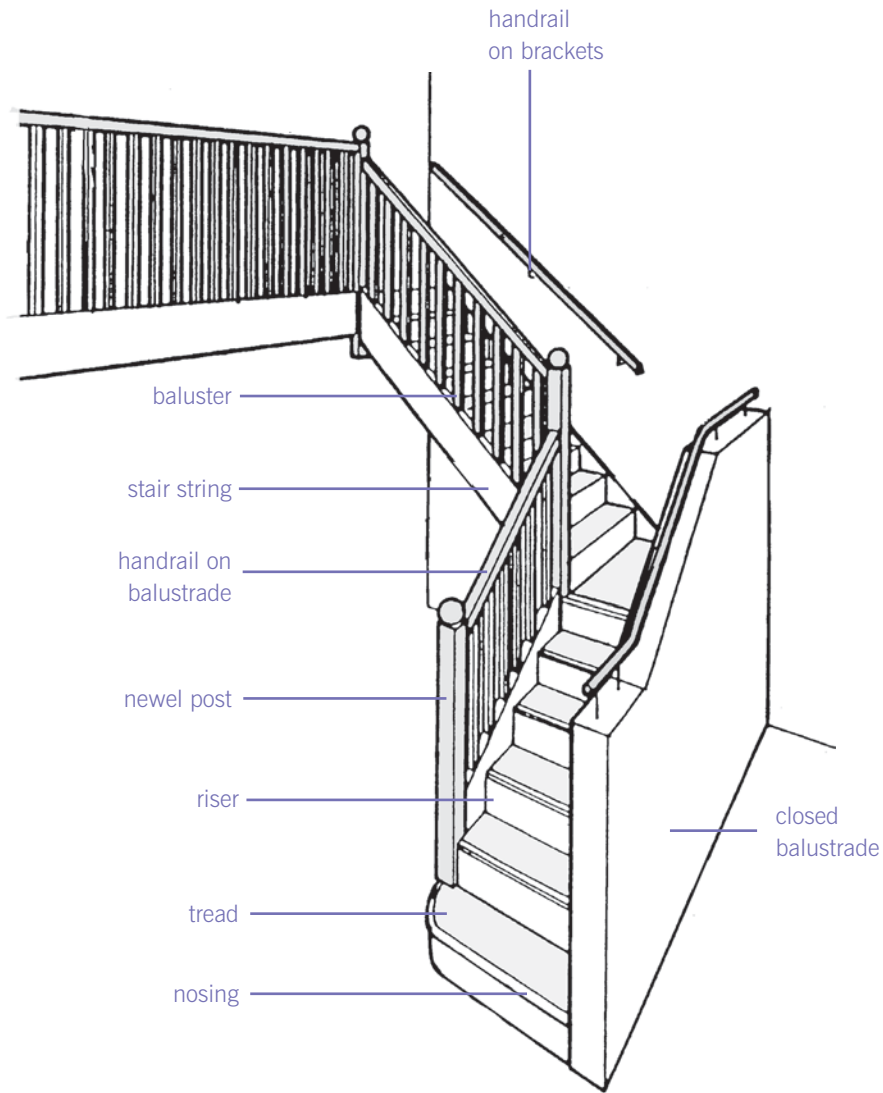

**Before you contact us:**

- If hazardous, warn others.
- If hazardous, warn others.

**Tell us:**

**Loose tread**

- Is it inside your home or a communal staircase?
- How many are affected?
- What are the stairs made of? (wood, concrete etc)

**Loose floorboard**

- Is it inside your home or a communal area?
- What is the rough size of affected area?

**Handrail or balustrade defective**

- Is it inside your home or a communal area?
- Which part is affected? (handrail, post, individual baluster, bracket etc. See diagram opposite)
- Can it be refixed or does it need to be replaced?



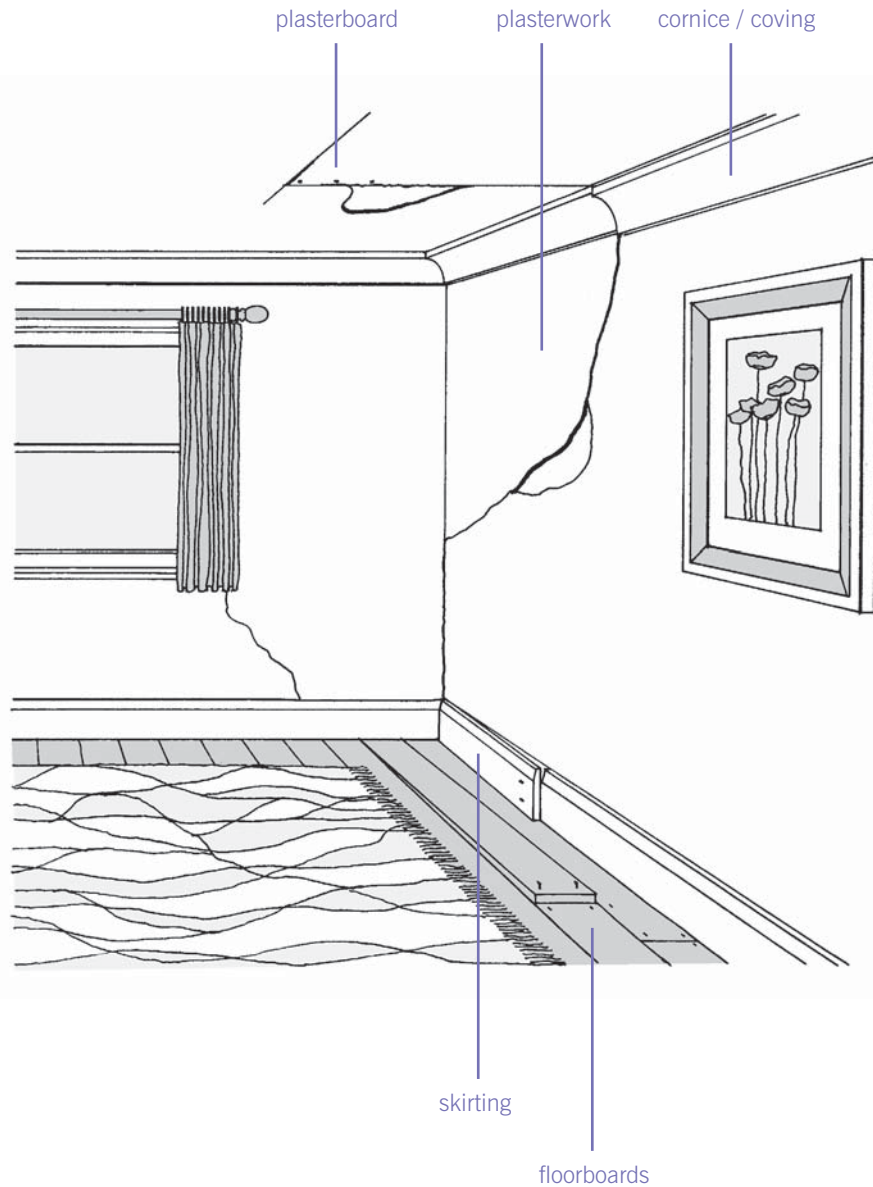

**Tell us:**

**Floorboards**

- Are the floorboards loose or broken?
- If broken, is wood crumbling or rotting?

**Plaster repairs**

- Is there a crack in the plaster or is a patch damaged?
- Where is the damage? (wall, ceiling, door or window frame, coving?)
- How large is the affected area?

**Skirting board**

- Is the skirting board broken or loose?
- If broken, is wood crumbling or rotting?

**Vermin**

- Have you seen mice or mouse droppings?

**Floor tiles**

- Are the tiles loose, broken or missing?
- What type of tile (ceramic, quarry, vinyl)?
- What size area is affected?

- Infestations are usually your responsibility

# HELPFUL TIPS

## LOOKING AFTER YOUR HOME

You are responsible for keeping the inside of your home in good condition. To help you do this it is best to carry out small tasks and checks to prevent future problems such as:

- Wipe down on a regular basis all windows affected by condensation and if any mould has formed clean it off using a wash of diluted bleach, or a proprietary product available from DIY shops.
- Limescale can be removed from baths, sinks, shower heads, and taps with a descaler available from DIY shops.
- Blockages in kitchen sink waste pipes can be prevented by flushing through using drain clearing product.
- Outside gullies should be kept clear of leaves and other debris so that water drains away easily.
- Make sure you know where the main stopcock is, and how to turn it off. Also, be sure to know how to turn off your electricity and gas supply in an emergency. If you do not, ask any of our staff or contractors when they next visit you.

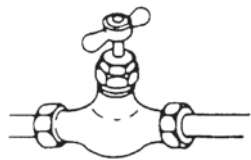

Stopcock, stop valve or stop tap

In the Autumn you should check the following list of items and notify us of any problems. We can then repair them before they get worse and cause you any inconvenience:

- If you use an open fire have you swept the chimney? This is normally your responsibility.
- Are all your heating controls set correctly?
- Are there any tiles or slates missing or broken on your roof?
- Are there any leaks or blockages from gutters and downpipes?

## CONDENSATION

Condensation occurs when there is an excessive build up of moisture in the air. There is always moisture in the air, but people create additional moisture in their homes by:

- Cooking, or boiling water
- Taking baths or showers
- Using paraffin or bottled gas heaters
- Drying clothes indoors

Warm moist air condenses and forms water when it cools: for example when it touches a cool surface. In your home these are outside walls, mirrors, windows, wall tiles and even on clothes.

If this condensation cannot dry out it will cause mould to form on walls, in cupboards and on window sills, and mildew to form on clothes, especially leather goods.

There are four things you can do to stop condensation forming:

- Produce less moisture by covering pans and turning down the heat when boiling, switching off boiling kettles, and drying clothes outside, or in a well ventilated room, and not using paraffin or bottled gas heaters.
- Ventilation to let the moisture out, by opening a bathroom or kitchen window for a while to let the steam escape, or using an extract fan; and by opening windows for a while each day to change the air in your house.
- Keeping your home warm by at least keeping a low background heat: this need not result in significantly increased heating costs.
- Wipe down where moisture settles.

## LEAKING, BURST OR FROZEN PIPES

### When pipes leak

Place a dish or bowl underneath the leak. Pull back any carpets and lay down newspapers or towels to absorb any dampness.

### When pipes burst

Turn off the water at the main stopcock, and any gate valves from the water tank, and switch off any water heaters. Open all taps to drain water from the system.

### Can it be isolated?

Some items of equipment may have their own isolation valve (either a gate valve, or a service valve). If not, you may be able to isolate the fault by just turning off a gate valve on a pipe coming out of

the cold water tank. This will leave you with some services, even though it might only be cold water at the kitchen tap. You could then temporarily flush toilets using a bucket of cold water.

Gate valve

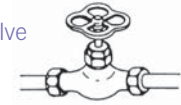

Service valve



## If electric fittings get wet

DO NOT TOUCH and turn off electricity at the meter

## When ceilings bulge

To prevent the ceiling falling down, place a bucket under the bulge and pierce a small hole to let the water through.

## When pipes freeze

Turn off the water at the main stopcock and open the cold taps. It is best to leave the pipes frozen but you may try to thaw the pipe i.e. using hot water bottles or a hair dryer. DO NOT USE A BLOW LAMP. Take care to thaw from one end of the frozen section and not from the middle. Conserve hot water until the pipes are thawed.

## General information

Know where your main stopcock is and check that it turns easily and is able to shut off the water supply. It is usually where the water pipe enters the house or near the kitchen sink. Get to know where the gate valves for the hot and cold water tanks are.

If you go away for a few days in winter, lower the setting on your central heating room thermostat but leave the heating on.

## BLEEDING A RADIATOR

### When to do it

If the top part of a radiator is cold, this is because air is trapped in the system. Bleeding the radiator releases this air and allows hot water to fill the whole system.

### Do not bleed if

Do not bleed the radiators if you have a Combination Boiler: this type of boiler will have either a pressure gauge or a low pressure light on the front or underside of the boiler, and you will probably not have a hot water cylinder.

### Before bleeding

If the whole radiator is cold, check that the radiator valve is open. If more than one radiator is cold, the whole heating system may need to be checked by a plumber.

Turn off the heating system before bleeding, otherwise the pump might draw more air into the system.

You will need a special radiator key, available from most DIY and hardware shops. You will also need a rag or cloth and a bucket or bowl.

### How to bleed

The bleed valve is the small square nut at the top end of the radiator. Place the key over the valve and hold the cloth around it to catch any water. Gently turn the key anti-clockwise until you hear a hiss - this

is the air being released. When water starts to come through, turn the key back clockwise to shut the valve off. **DO NOT** unscrew the valve completely as the plug will come right out.

### Bleeding a radiator

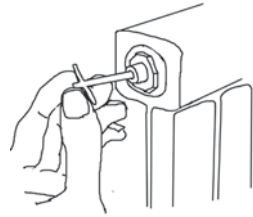

### Thermostatic radiator valve

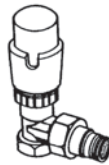

## LOSS OF ELECTRIC LIGHT OR POWER

### Warning

- Never tamper with the electricity company's fuse and seals.
- If in doubt, contact your landlord.

### Turning off electricity

- If you need to turn off all electricity (eg because of water penetration), use the main ON/OFF switch on the consumer unit.

## Fuse or trip switch

Check your consumer unit or fuse box: it will either have fuses or trip switches (see diagrams). Modern electric circuits are fitted with a circuit breaker fuse system: if a fault develops, a switch is tripped and the circuit is broken.

### Electricity consumer unit

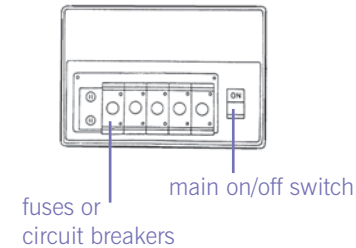

### Fuses

#### Trip switch

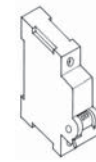

#### MCB

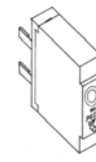

Trip switch  
(replaces fuses  
in modern  
consumer  
units)

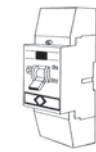

### When a switch is tripped

Open the cover on the consumer unit to expose the trip switches. The Consumer Unit is usually next to the electricity meter. Check which switches have tripped to the OFF position and put them back to the ON position. For more detail, refer to any information supplied.

## If tripping occurs again

It is probably being caused by a faulty appliance. You need to identify which circuit is affected and which appliance on that circuit is causing a problem.

## Which appliance is faulty?

Go around the house noting which set of lights or sockets are not working. Unplug all appliances on that problem circuit and switch off the immersion heater. Switch the tripped switch to the ON position and plug in the appliances one by one until the trip goes again. Leave that appliance unplugged. If one of our appliances is at fault, report the repair; otherwise get it fixed yourself by a qualified electrician or service engineer.

## What causes it to trip or blow a fuse?

- An overloaded circuit
- Too many appliances being used at the same time
- A faulty or misused appliance
- Over filled kettles
- Unclean toasters
- Cooker rings worn out or cracked
- Faulty immersion heaters
- Faulty connections on leads to appliances, eg hi-fi, TV, etc
- Light bulbs blowing

## Plugs

The socket outlets in your home will take square pin plugs. The plug which you require will have a fuse inside it. We do not supply plugs and you will have to obtain them yourself. To find out the correct type of fuse to fit in a plug, check the rating plate on the appliance. Do not overload plug sockets by using multiple plug adaptors.

## CONTROLLING YOUR CENTRAL HEATING

### How to set a digital timer

Check the clock is showing the correct time. If not, put the timer switch to 'clock' and adjust the time using the 'forward' and 'reverse' buttons. Reset the timer switch to 'auto'. Set the 'heating' and 'hot water' switches to come on once, twice, or stay on all the time, as you require. During freezing spells, keep the heating on all the time, and turn the thermostat down during the night and if you are out all day.

### How to set a clock timer

Turn the clock until it is showing the correct time. Decide when you want the heating to come on and go off and set the pins or arrows for those times (see below for how to change pins and arrows). Set the timer switch to 'timer' or 'auto' as appropriate to the unit. During freezing spells, keep the heating on all the time, and turn the thermostat down during the night and if you are out all day.

### How to control the temperature

To set the thermostat turn the dial so that the arrow or marker is against

the temperature setting you want. A comfortable temperature is between 18°C and 22°C.

### Changing pins on timeclock

Push them in against any time you want the heating on. Pull them out against any time when you want the heating off.

### Changing arrows on timeclock

Slide the 'on' arrows (usually red) around the clock to the times when you want the heating to come on. Slide the 'off' arrows (usually blue) around to the times when you want the heating to go off.

#### Heating controls

##### Digital programmer

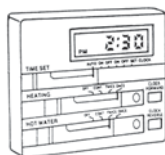

Clock programmer

##### Storage heater

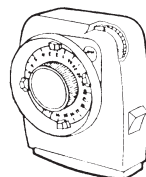
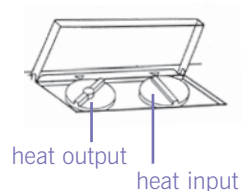

Thermostat

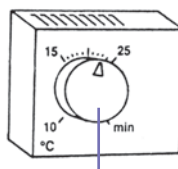

temperature dial

## CLEARING A BLOCKED WASTE PIPE

### Clearing a sink or bath blockage

Bail out most of the water using a suitable container. Hold a cloth or rag firmly over the overflow opening, and place a plunger over the drain hole. Pump the plunger up and down rapidly. Plungers can be obtained from most DIY shops. After clearing the blockage, it is advisable to clean out the waste trap.

#### Clearing a blocked waste pipe

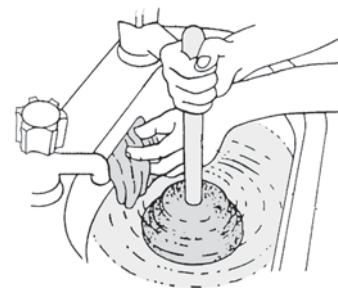

### Cleaning out a waste trap

First bail out any excess water from the bath, basin, or sink using a jug or bowl. Place a bowl underneath the trap and unscrew the joints to remove the trap. Clean thoroughly and replace the trap, checking that the seals are in place and that all joints are screwed up tightly.

### If more than one fitting is blocked

The problem may be in the soil stack or main drain. This will need to be cleared by one of our contractors. Blockages are usually caused by the build-up of fat, tea leaves, hair, etc. It is advisable to clean wastes with a drain clearing product.

## CLEARING A BLOCKED WC

### Clearing blockages

If the pan is already full, remove most of the water into a suitable container using a jug or bowl. Push the toilet brush or plunger to the bottom of the pan and pump up and down vigorously about 10 times. This creates a vacuum and pressure which may shift the blockage. Check by flushing the toilet to see whether the blockage has gone. You may need to repeat the process several times before the toilet flushes normally. Do not use plungers with a metal disk, as these may chip or crack the toilet bowl.

#### Clearing a blocked WC

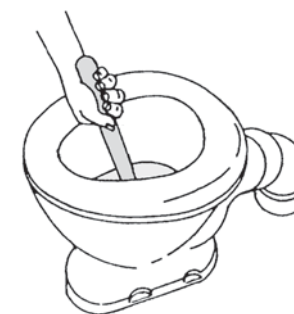

### Avoiding blockages

Air fresheners that attach to the rim of the toilet pan should be fastened securely to ensure they do not fall in and cause a blockage. Blockages are usually caused by unusual objects: nappies, toys, sanitary towels, air fresheners, etc. If such a blockage occurs as a result of one or several of these objects becoming lodged, you may be charged for clearing the blockage.

## OVERFLOWS

### To stop an overflow

If the toilet cistern is overflowing try lifting the float to close the ball valve: if this stops the overflow, try to tie it up, using a piece of wood and some string, as in the diagram.

Toilet cistern

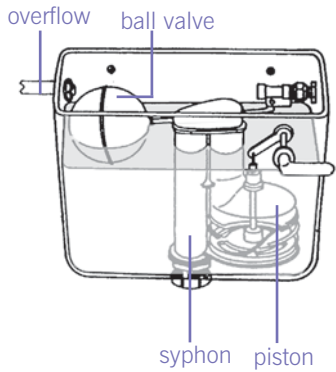

Cistern showing float tied up

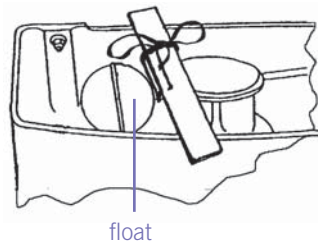

You can do the same with a cold water storage tank as a temporary measure.

Cold water storage tank

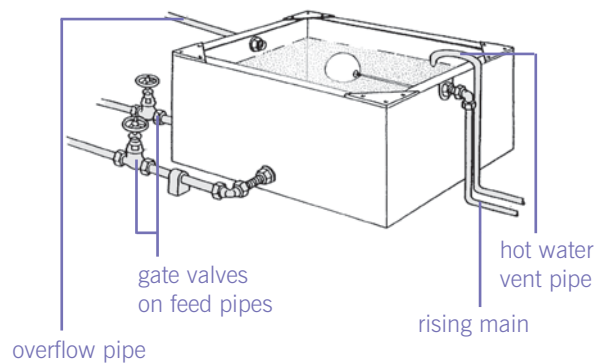

## STOPCOCKS, GATE VALVES ETC

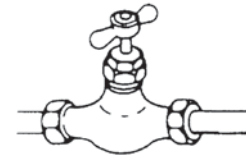

Stopcock, stop valve or stop tap

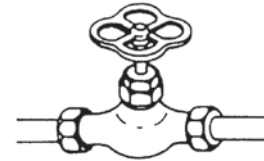

Gate valve



Service valve

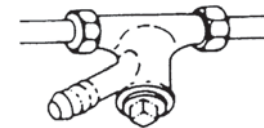

Draincock



Stopcock with drain valve



# REPAIRS INDEX

<b>Basin</b>		<b>Electrical fitting smoking</b>	<b>121</b>	<b>Lighting</b>		<b>Splashback / tiles damaged</b>	
Blocked	87	<b>Extract fan faulty</b>	<b>121</b>	Failed	121	Around bath / basin	89
Damaged / broken	87	<b>Fence dangerous / broken</b>	<b>127</b>	Fluorescent tube gone	121	Around kitchen sink	113
Tiles damaged	89	<b>Floors</b>	<b>143</b>	(Emergency lighting) faulty	139	Around shower	95
Seal gone	89	<b>Fumes in room</b>	<b>119</b>	(Communal lighting) faulty	139	<b>Stairs</b>	
Tap dripping / faulty	89	<b>Garage door faulty</b>	<b>129</b>	<b>Locked out</b>	<b>105</b>	Handrail / balustrade	
Tap loose	89	<b>Gate</b>		<b>Manhole</b>		or spindle loose	141
Water leaking	87	Damaged	125	Cover broken	135	Floorboard loose	143
<b>Bath</b>		Jamming / sticking	125	Overflowing	135	Tread loose	141
Blocked	87	Latch / bolt faulty	127	<b>Path damaged</b>	<b>131</b>	<b>Tank (storage) overflowing</b>	<b>97</b>
Damaged / broken	87	Post rotten / broken	127	<b>Pipe</b>		<b>Tap dripping / faulty on basin/bath</b>	<b>89</b>
Tiles damaged	89	Post stop damaged	127	Banging	97	<b>Tap loose on bath / basin</b>	<b>89</b>
Panel loose	89	<b>Gully</b>		Burst	97	<b>Threshold damaged</b>	<b>101</b>
Seal gone	89	Blocked	135	<b>Plug socket failed</b>	<b>123</b>	<b>Tiles (wall) damaged</b>	
Tap dripping / faulty	89	Cover defective	135	<b>Power: none at all</b>	<b>121</b>	Bath / basin	89
Tap loose	89	<b>Guttering / downpipe faulty</b>	<b>137</b>	<b>Radiator</b>		Kitchen sink	113
Water leaking	87	<b>Gutter overflowing</b>	<b>135</b>	Leaking	119	Shower	95
<b>Boiler (central heating) faulty</b>	<b>117</b>	<b>Heating</b>		Not heating up	117	<b>TV aerial (communal) faulty</b>	<b>139</b>
<b>Chimney damaged</b>	<b>133</b>	Communal	117	<b>Roof damaged</b>	<b>133</b>	<b>Walls</b>	<b>143</b>
<b>Cupboard (kitchen) damaged</b>	<b>113</b>	Radiant / convector heater faulty	119	<b>Rubbish chute faulty</b>	<b>139</b>	<b>Wall (garden) dangerous</b>	
<b>Door (internal)</b>		Storage heater faulty	119	<b>Sealing strip gone</b>		<b>or collapsed</b>	<b>129</b>
Damaged	107	<b>Helpful tips</b>	<b>144</b>	Around basin or bath	89	<b>Washing machine blocked</b>	<b>115</b>
Sticking / jammed	107	<b>Hot water stopped</b>	<b>99</b>	Around shower	93	<b>Waste blocked (bath / basin)</b>	<b>87</b>
Latch damaged	107	<b>Keys lost</b>	<b>105</b>	Around kitchen sink	115	<b>Water</b>	
<b>Door (external)</b>		<b>Kitchen</b>		<b>Shower</b>		Hammer/banging pipes	97
Draught	103	Cupboard	113	Blocked	95	Leaking	97
Frame damaged / rotten	101	Drawer	113	Cubicle door faulty	95	Leaking from bath / basin	87
Glass damaged / broken	103	Wall tiles	113	Hose broken	95	No cold water	97
Fittings	105	Sink	115	Not working	93	Tank overflow running	97
Jammed	101	Floor tiles	143	Seal gone around tray	93	<b>WC</b>	
Lock not working	105	<b>Leak</b>		Shower arm broken	95	Blocked	93
Rain coming in	103	From bath / basin	87	Switch broken	95	Leaking	91
Threshold damaged	101	From kitchen sink	115	Tray broken	93	Flush not working	91
Weatherboard damaged	103	From radiator	119	Tiles damaged	95	Overflow running	91
<b>Door entry faulty</b>	<b>139</b>	From waste trap (kitchen)	115	<b>Sink (kitchen)</b>		Seat damaged	91
<b>Downpipe / guttering faulty</b>	<b>137</b>	From WC	91	Blocked	115	Soil stack blocked	93
<b>Drains blocked</b>	<b>135</b>			Tap dripping	115	<b>Window</b>	
<b>Electrics: none at all</b>	<b>121</b>			Tap loose	115	Frame jammed / sticking	109
<b>Electrical appliance faulty</b>	<b>123</b>			Unit leaking	115	Glass damaged / broken	109
				<b>Slates damaged</b>	<b>133</b>	Fittings	111
				<b>Smoke detector faulty</b>	<b>123</b>	<b>Weatherboard damaged</b>	<b>103</b>
				<b>Soil stack blocked</b>	<b>93</b>		



# INVESTING IN HOMES & NEIGHBOURHOODS

## Decent Homes

The Decent Homes Standard was brought in by central government to ensure that all social housing is maintained to at least a minimum standard, set by central government. For a home to be 'decent' it must be in a reasonable state of repair, have reasonably modern facilities e.g. kitchen & bathroom, be reasonably efficient to heat and be free from severe risk to health and safety.

The Decent Homes Standard required all social landlords to bring their properties up to this minimum standard by 2010. CBH developed the Creating Better Homes programme to deliver the necessary works and reached decency in 2008. However every year some properties potentially become non decent. CBH continually monitor compliance with this standard and develops programmes of work to ensure that the homes are maintained to the decent homes standard.

To enable us to do this we carry out regular stock condition surveys to assess when works will be required.

In addition to works required to meet the decent homes standard we have programmes for improvement works including neighbourhood works, the installation of door entry systems and works required as a result of fire risk assessments. These programmes are developed in consultation with residents.

If you would like to find out how you can be involved in monitoring work in your neighbourhood or become involved in partnering procurement, please contact the Community Involvement team on 0800 408 0000 or email [communityinvolvement@cbh.org](mailto:communityinvolvement@cbh.org)

## Cyclical programmes

CBH have developed a cyclical programme for the redecoration of previously decorated components to external areas and internal communal areas to blocks of flats. The programme is set up on an area basis and details of the programme are published on the CBH website and also at area offices.



# YOU AND YOUR NEIGHBOURHOOD



# YOU AND YOUR NEIGHBOURHOOD

## Section 1 Your Neighbourhood Handbook

---

## Section 2 Being a good neighbour

---

Anti-social Behaviour  
Domestic Abuse  
Harassment and Hate Crime  
Victim Support

## Section 3 Neighbourhood Works

---

Annual Programme of Work

## Section 1

# YOUR NEIGHBOURHOOD HANDBOOK

YOUR  
NEIGHBOURHOOD  
HANDBOOK

---

# YOUR NEIGHBOURHOOD HANDBOOK

In 2014 CBH updated individual local Neighbourhood Handbooks for each CBH neighbourhood area. Consultation was by various methods, including survey forms to all residents regarding their views on their neighbourhood. We asked about the positive things about living there, as well as those that are not so good.

The Neighbourhood Handbooks include information about:

- Who your local CBH staff team are and how to contact them
- Information about the CBH Estate Cleaning Service and the Grounds Maintenance service provided to us by Ubico
- Contact details for other CBH and Council services
- There is also information on local amenities and services.

With these Neighbourhood Handbooks, we have developed local Action Plans to try to combat the issues identified in each area. These are reviewed annually with plans updated to show progress and what will be done in the following 12 months.

For more information, please contact your Neighbourhood Housing Officer on 0800 408 0000, or see our website at [www.cbh.org](http://www.cbh.org)

## Section 2

# BEING A GOOD NEIGHBOUR

### BEING A GOOD NEIGHBOUR

---

Anti-social Behaviour

---

Domestic Abuse

---

Harassment and Hate Crime

---

Victim Support

---

# BEING A GOOD NEIGHBOUR

When you signed your tenancy agreement you agreed to be responsible for the behaviour of everyone living in or visiting your home. This is to make sure that you and your neighbours can live in your homes in peace and comfort. It is also to make sure that your neighbourhood is a pleasant and safe one to live in.

## Anti-social behaviour

CBH believes that everyone has the right to get on with their lives without being troubled by other people's behaviour. We take problems of anti-social behaviour very seriously and we are determined to do whatever we can to stop it.

Anti-social behavior (ASB) often involves criminal behaviour. All criminal behaviour should be reported to the Police. In cases of emergency ring 999, otherwise ring 101 or Crime stoppers on 0800 555 111. CBH and Gloucestershire Constabulary are committed to working in partnership to make Cheltenham a safer place to live.

Anti-social behaviour is behaviour that causes genuine nuisance and can range from problems with rubbish filled gardens to more serious problems such as drug dealing or harassment.

Examples of anti-social behaviour are listed below:

- playing music too loudly
- having noisy parties with rowdy visitors
- willfully damaging property
- fly-tipping
- allowing criminal activity in properties such as drug dealing
- graffiti
- irresponsible pet ownership such as allowing your dog to foul and not clearing it up or allowing your dog to roam off the lead in communal areas
- breaking shared security, for example by allowing strangers to get into the building
- verbal abuse such as shouting, swearing and threatening words

- discriminating against anyone because of their colour, beliefs, age, race, sex, disability, gender or sexuality
- violence or threats of violence

You are responsible for the actions of your family, other people who live with you and your visitors. You must not allow visitors to be a nuisance or to annoy others in or near to your home.

You must not use or allow your home to be used for an illegal or immoral purpose, such as prostitution, dealing in pornography or drugs.

You must not store motorcycles and flammable materials in Council property, storage sheds or communal areas.

You must not threaten, abuse or harm our staff or anyone else acting for us.

We may take legal action if you, your family or your visitor behave anti-socially. This can threaten your tenancy.

## What can I do?

If you or someone you know is suffering from anti-social behaviour, there are a number of things you can do:

- contact a member of the Safer Estates Team on 0800 408 0000 or visit your local CBH office
- contact the police on 101 or 999 if it is an emergency
- contact Crime stoppers on 0800 555 111 (you do not have to give your name)

In many cases problems can be resolved by tenants talking to each other. Your neighbour may not be aware that they are causing a problem.

You can also keep a written record of all incidents showing where and when it took place and who was involved. Your Safer Estates Officer can provide you with diary sheets.

## What can CBH do?

Most importantly, we cannot start to solve a problem until we know about it, so please tell us if you are experiencing difficulties. Information can be given in confidence.

Often all that is required to solve a problem is for the person causing it to be contacted and spoken to.

Sometimes however court action is required that can result in people being ordered to behave or even being ordered to leave their home. In cases that involve threats or use of violence people can be excluded from an area.

**Do not suffer in silence.**

Remember: we cannot do anything unless you tell us about the situation. We have helped and supported many tenants who are being disturbed and/or harassed by their neighbours.

## Domestic Violence and Abuse

Domestic violence and abuse is unacceptable, CBH will provide support and advice to any individuals affected by this.

**The definition of domestic violence and abuse is:**

Any incident or pattern of incidents of controlling, coercive, threatening behaviour, violence or abuse between those aged 16 or over who are, or have been, intimate partners or family members regardless of gender or sexuality. The abuse can encompass, but is not limited to:

- psychological
- physical
- sexual
- financial
- emotional

**Controlling behaviour:**

Controlling behaviour is a range of acts designed to make a person subordinate and/or dependent by isolating them from sources of support, exploiting their resources and capacities for personal gain, depriving them of the means needed for independence, resistance and escape and regulating their everyday behaviour.

**Coercive behaviour:**

Coercive behaviour is an act or a pattern of acts of assault, threats, humiliation and intimidation or other abuse that is used to harm, punish, or frighten their victim.

This is not a legal definition.

**Coercive or controlling behaviour offence:**

A coercive or controlling behaviour offence came into force in December 2015. It carries a maximum 5 years' imprisonment, a fine or both. Victims who experience coercive and controlling behaviour that stops short of serious physical violence, but amounts to extreme psychological and emotional abuse, can bring their perpetrators to justice.

The offence closes a gap in the law around patterns of controlling or coercive behaviour that occurs during a relationship between intimate partners, former partners who still live together or family members.

**Forced marriage**

Forced marriages are against the law in the UK. If you, or someone you know, feels they are being forced to marry, please speak to your Housing Officer to find out what help is available. Private interview rooms are available at our area offices and all information will be treated confidentially.

**Domestic abuse and young people:**

The changes to the definition of domestic abuse has raised awareness that young people in the 16 to 17 age group can also be victims of domestic violence and abuse. By including this age group the government hopes to encourage young people to come forward and get the support they need, through a helpline or specialist service.

**Domestic violence disclosure scheme:**

**Right to ask**

Under the scheme an individual can ask police to check whether a new or existing partner has a violent past. This is the 'right to ask'. If records show that an individual may be at risk of domestic violence from a partner, the police will consider disclosing the information. A disclosure can be made if it is legal, proportionate and necessary to do so.

**Right to know**

This enables an agency to apply for a disclosure if the agency believes that an individual is at risk of domestic violence from their partner. Again, the police can release information if it is lawful, necessary and proportionate to do so.

**Domestic violence protection notices and orders:**

A Domestic Violence Protection Notice ("DVPN") may be issued by an authorised Police Superintendent, which has prohibitions to bar a suspected perpetrator from returning to either a victim's home and/or contacting the victim.

Following the issue of the DVPN the Police must apply to the Magistrates for a Domestic Violence Prevention Order ("DVPO"). If the required conditions are met the DVPO will be granted.



The DVPN and DVPO are not criminal orders and do not form part of any criminal history for the alleged offender. Alleged offenders still have access to legal advice at the Police Station\* and at Court\* via the Duty Solicitor Scheme or having made prior arrangements for legal representation.

The reason for these new powers for the Police is to enable a period of reflection and enable parties to get help, advice and guidance.

The Orders will last for a maximum for 28 days. Breaches are dealt with as if a breach of bail, but the DVPO is not extendable past the maximum 28 day period.

As part of the additional support a victim may need, the Legal Aid Agency have widened their criteria for evidence which may be provided to support an application for Legal Aid to include the DVPN's and DVPO's.

### **Report abuse**

If you are, or someone you know is, a victim of domestic abuse or violence find out how to report domestic abuse and where to get help from your local housing officer.

## Dealing with Hate Crime

We aim to eliminate unlawful discrimination, promote equality of opportunity and good relations between people of different racial and social groups. You may feel you are being harassed because of your race, age, sex, disability, sexuality, culture or religion.

This is known as hate crime and should not be tolerated.

Examples of the type of harassment that could be considered as hate crime are:

- Behaviour that is verbally or physically intimidating, threatening, degrading, humiliating or offensive.

It can also include damage to property such as offensive graffiti written on doors or walls.

It can be a single act or a persistent problem.

Anyone found responsible for harassment is in breach of their tenancy conditions. If you or any member of your family is harassed please report it to us so we can investigate it.

## Victim Support

CBH is committed to offering complainants of anti-social behaviour help and support.

We will:

- ensure complainants are dealt with in a timely manner
- agree any actions we take with complainants first
- keep the complainant informed of what action is possible
- carry out risk assessments with complainants to ensure we can respond to any risks identified
- take appropriate action under the law to stop anti-social behaviour

## Tenancy Liaison

We have a Tenancy Liaison Officer who can help our more vulnerable tenants access services and local help.

If you would like more information, please ring 0800 408 0000 and ask to speak with a member of the Safer Estates Team.



## Section 3

# NEIGHBOURHOOD WORKS

### NEIGHBOURHOOD WORKS

---

Annual Programme  
of Works

---

# NEIGHBOURHOOD WORKS

Not all the improvements you want to see in your homes and neighbourhoods are part of the Decency Standard. Some of your priorities are extra to the standard and we have to secure separate funding to be able to carry out these works.

In response to your priorities a Neighbourhood Works programme has been developed. This aims to deliver improvements to internal and external communal areas to enhance the appearance and usefulness of the property or neighbourhood as a whole. This may include improvements to security, lighting and facilities such as drying areas.

We are committed to involving you in shaping the Neighbourhood Works. All residents in blocks where we plan to make these improvements are consulted and have their input prior to work beginning.

Other programmes of work have been developed to provide improvements including work to:

- external areas
- lift replacements
- door entry installations
- fire protection work

## Annual Programme of Work

We also carry out regular works on an annual basis to CBC and CBH homes, including the following:

- Servicing gas appliances
- Servicing communal lifts
- Servicing communal fire systems and emergency lighting
- Drain clearing
- Maintenance of communal lighting
- Maintenance of controlled door entry

Before any work is carried out on your home, we will give you adequate notice. If any of the works cause damage to decorations inside, we will provide a decoration voucher when the works are completed.

In exceptional circumstances CBH might have to move you out of your home whilst we carry out major repairs and improvements. We will offer you another home suitable for you and your family for the period that work is being carried out. We will consult with you throughout the process of any improvement works.

# CBH USEFUL CONTACTS

## FREEPHONE

**0800 408 0000**  
**0300 555 0121**  
(local rate calls)

## REPAIRS EMERGENCY

If you have an emergency repair outside CBH office hours then please call our freephone number:

**0800 408 0000**  
**0300 555 0121**  
(local rate calls)

Outside office hours we can only respond to genuine emergencies.

**VISIT**  
**[www.cbh.org](http://www.cbh.org)**

# OTHER USEFUL CONTACTS

Age UK	0800 678 1174
CCP (County Community Projects)	01242 228 999
Cheltenham General Hospital	0300 222 222
Cheltenham Job Centre	01242 845 000
Citizens Advice Bureau	01452 527 202
Crime Stoppers	0800 555 111
Domestic Violence advice line	0808 200 0247
Police	101
P3	0115 850 8190
RSPCA	0300 123 4999
Samaritans	01242 515 777
Gloucestershire County Council (Social Services helpdesk and Occupational Therapists)	01452 426 868
Frank (Drugs Helpline)	0300 123 6600

If you would like a translation or would prefer this information in Braille, large print or audio tape, please contact us on: 0800 408 0000 (4) or email: [communityinvolvement@cheltborohomes.org](mailto:communityinvolvement@cheltborohomes.org)

**Bengali/ বাংলা**

যদি আপনি এই তথ্য অনুবাদ আকারে পেতে চান, তাহলে দয়া করে আমাদের সাথে 0800 408 0000 (4) নম্বরে বা [communityinvolvement@cheltborohomes.org](mailto:communityinvolvement@cheltborohomes.org) ইমেইল ঠিকানায় যোগাযোগ করুন

**Portuguese/ Português**

Caso pretenda uma tradução desta informação, por favor contacte-nos através do: 0800 408 0000 (4) ou por e-mail [communityinvolvement@cheltborohomes.org](mailto:communityinvolvement@cheltborohomes.org)

**Polish/ Polski**

Jeśli chciałby Państwo otrzymać tłumaczenie niniejszych informacji, prosimy o kontakt pod numerem telefonu 0800 408 0000 (4) lub pisząc na adres: [communityinvolvement@cheltborohomes.org](mailto:communityinvolvement@cheltborohomes.org)

**Cantonese/ 廣東話**

倘若您想要此資訊的翻譯，請聯絡我們：0800 408 0000 (4)，或發送電郵：[communityinvolvement@cheltborohomes.org](mailto:communityinvolvement@cheltborohomes.org)

**Turkish/ Türkçe**

Bu bilgilerin kendi dilinize tercüme edilmesini isterseniz, lütfen 0800 408 0000 (4) numaralı telefondan ya da [communityinvolvement@cheltborohomes.org](mailto:communityinvolvement@cheltborohomes.org) adresinden bizimle irtibata geçin.

**Spanish/ Español**

Si le gustaría ver esta información traducida, póngase en contacto con nosotros en el número: 0800 408 0000 (4) o envíe un email a [communityinvolvement@cheltborohomes.org](mailto:communityinvolvement@cheltborohomes.org)

**Gujarati/ ગુજરાતી**

જો તમને આ માહિતીનું ભાષાંતર કરાવેલું જોઈતું હોય, તો મહેરબાની કરીને અમારો 0800 408 0000 (4) પર સંપર્ક કરો અથવા અમને [communityinvolvement@cheltborohomes.org](mailto:communityinvolvement@cheltborohomes.org) પર ઈમેઈલ કરો



**FREEPHONE 0800 408 0000**

**[www.cbh.org](http://www.cbh.org)**